

pbar-Source in HEFT of FAIR

(Status 2005, see new layout by S. Ratschow)

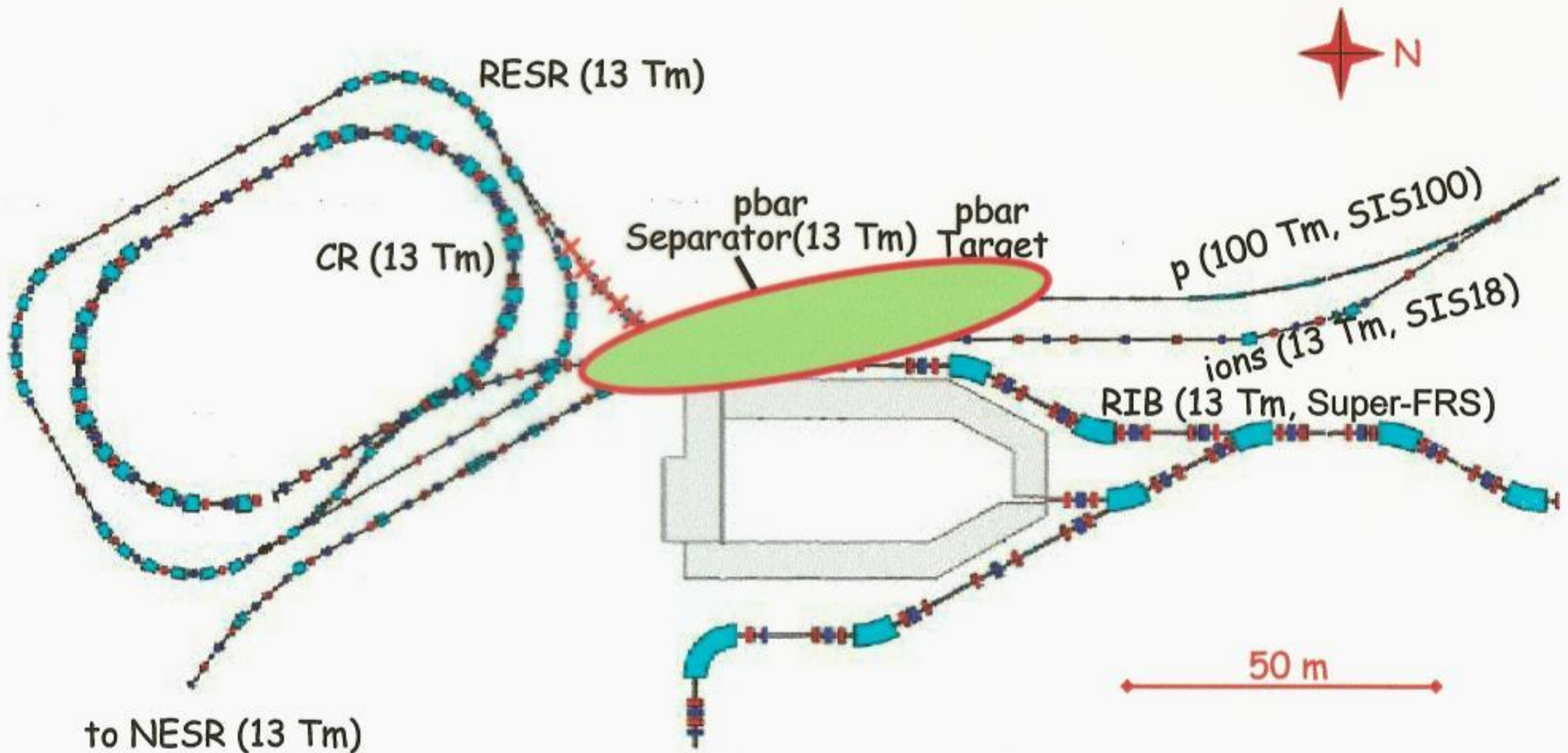

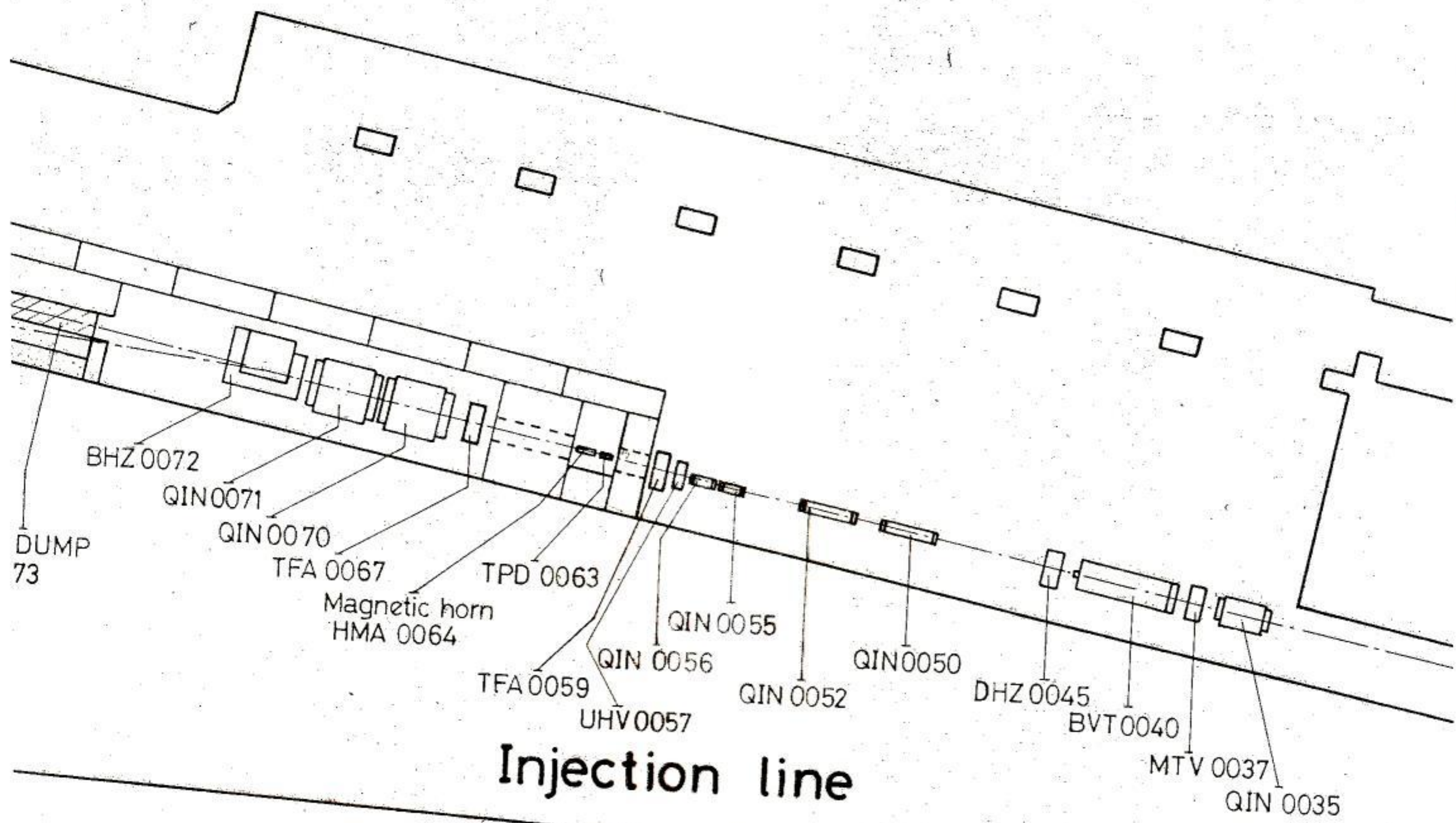

Injection line

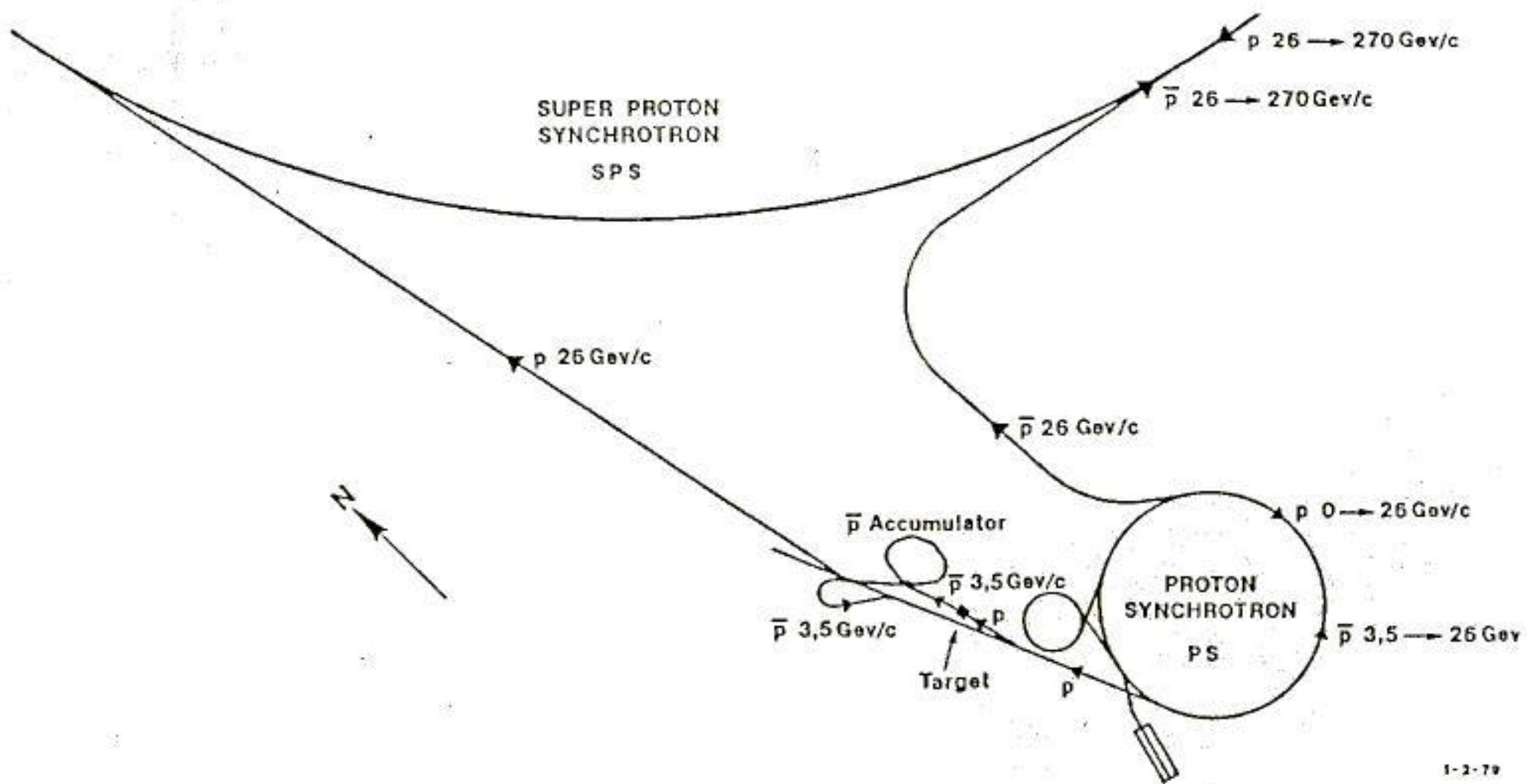

1-2-79

Fig. 1 Overall layout of the $p\bar{p}$ project.

Antiproton Source at CERN

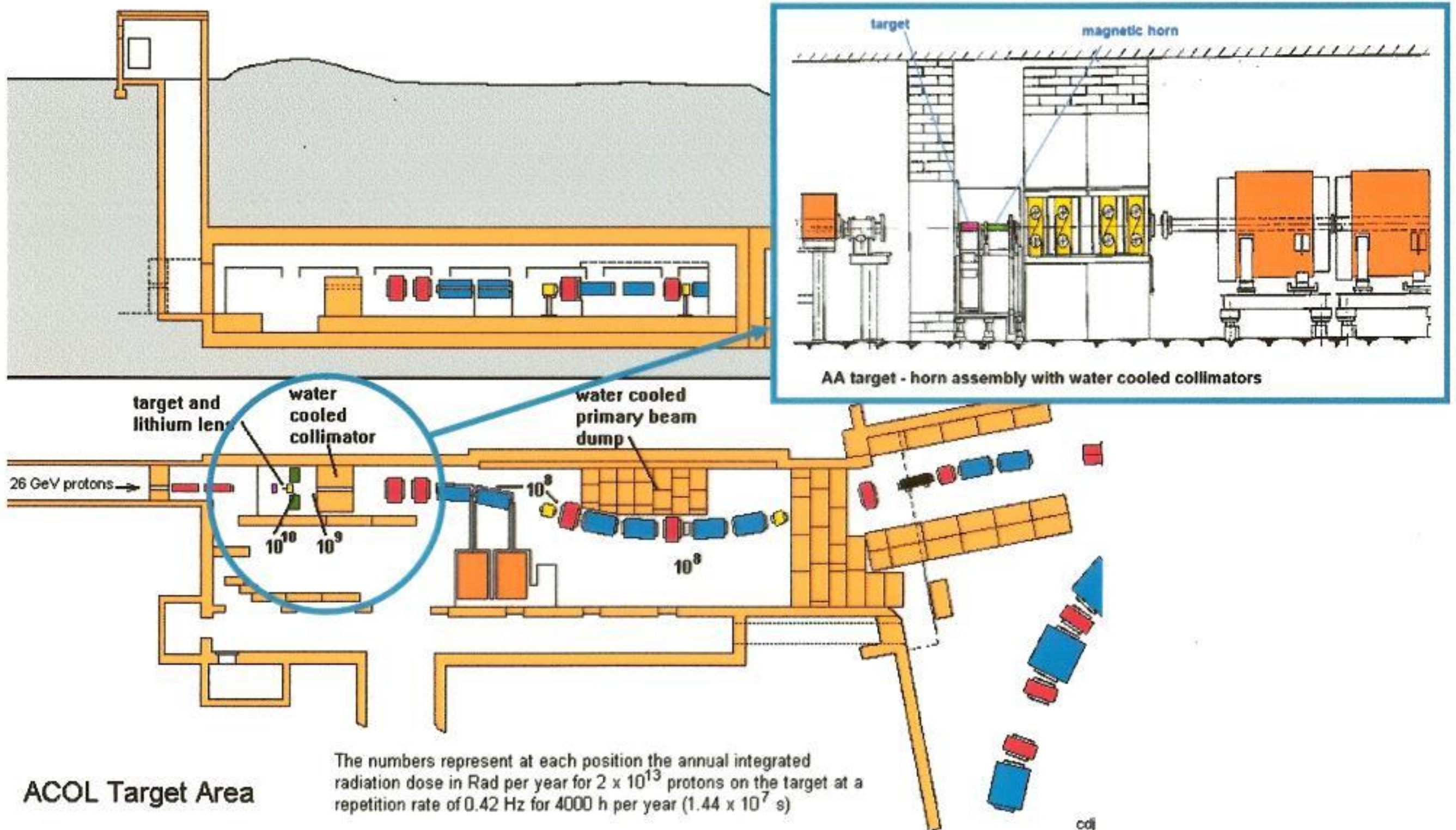

ACOL Target Area

The numbers represent at each position the annual integrated radiation dose in Rad per year for 2×10^{13} protons on the target at a repetition rate of 0.42 Hz for 4000 h per year (1.44×10^7 s)

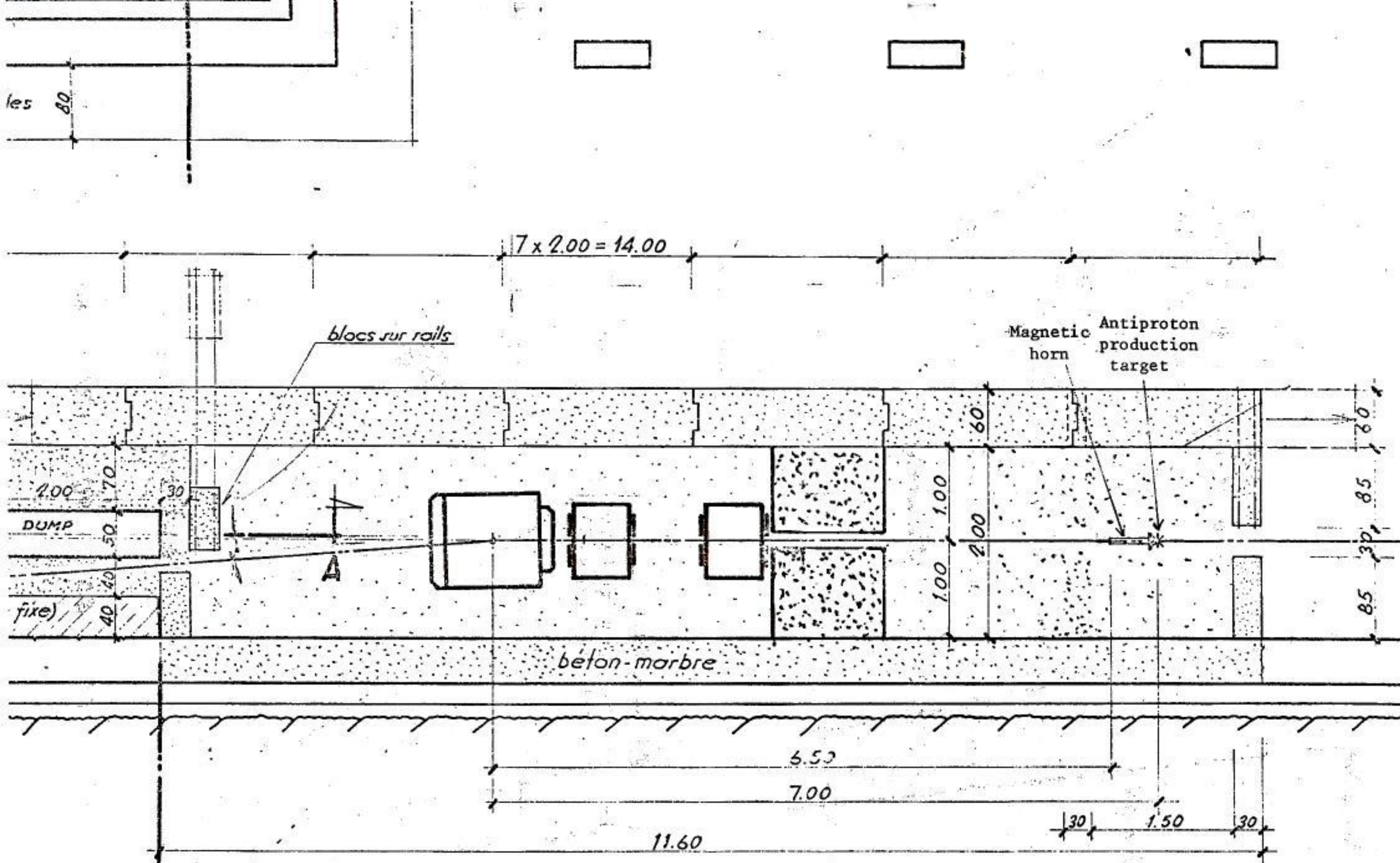

Fig. 1

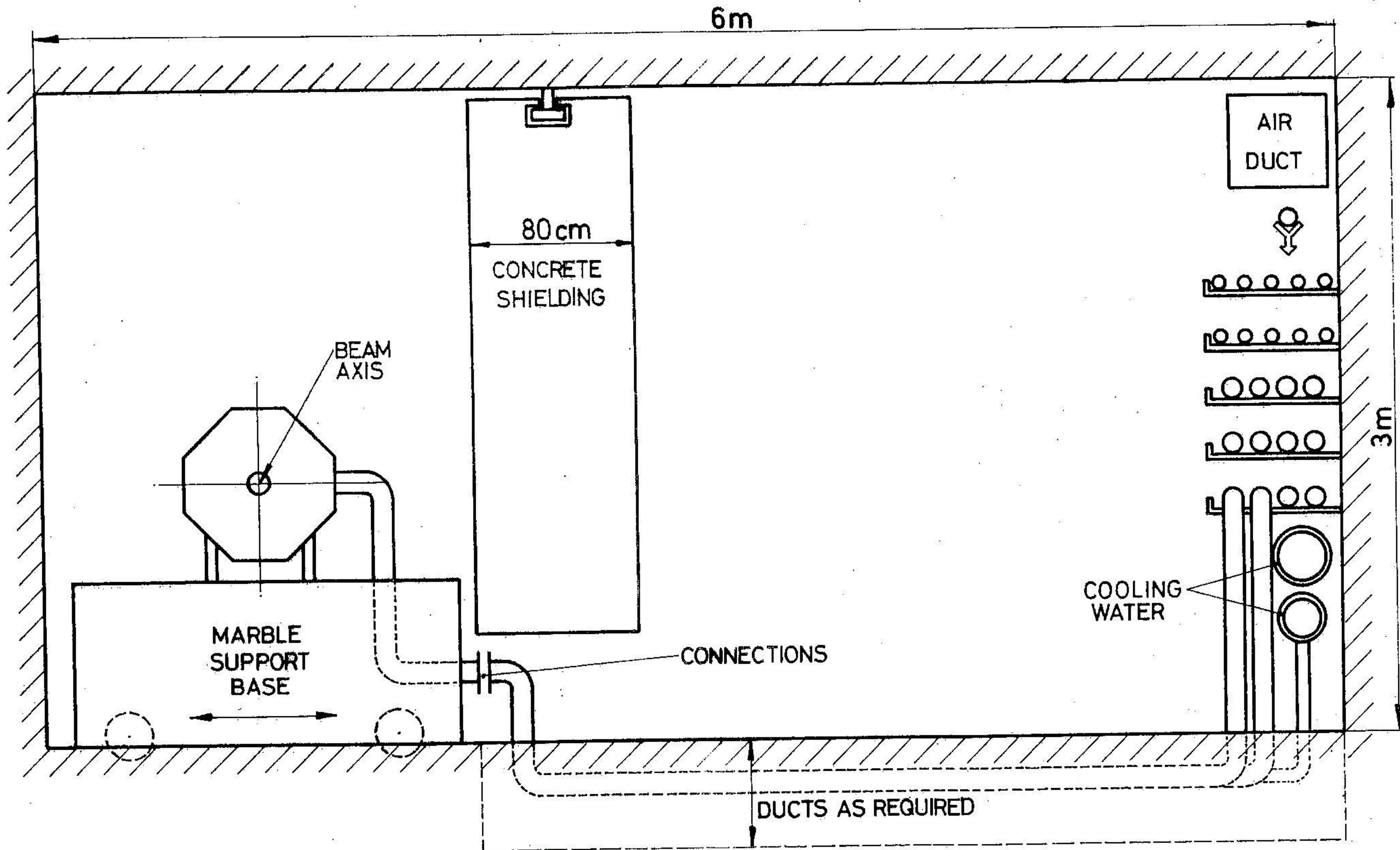

Fig. 9.2 Target area Schematic cross section

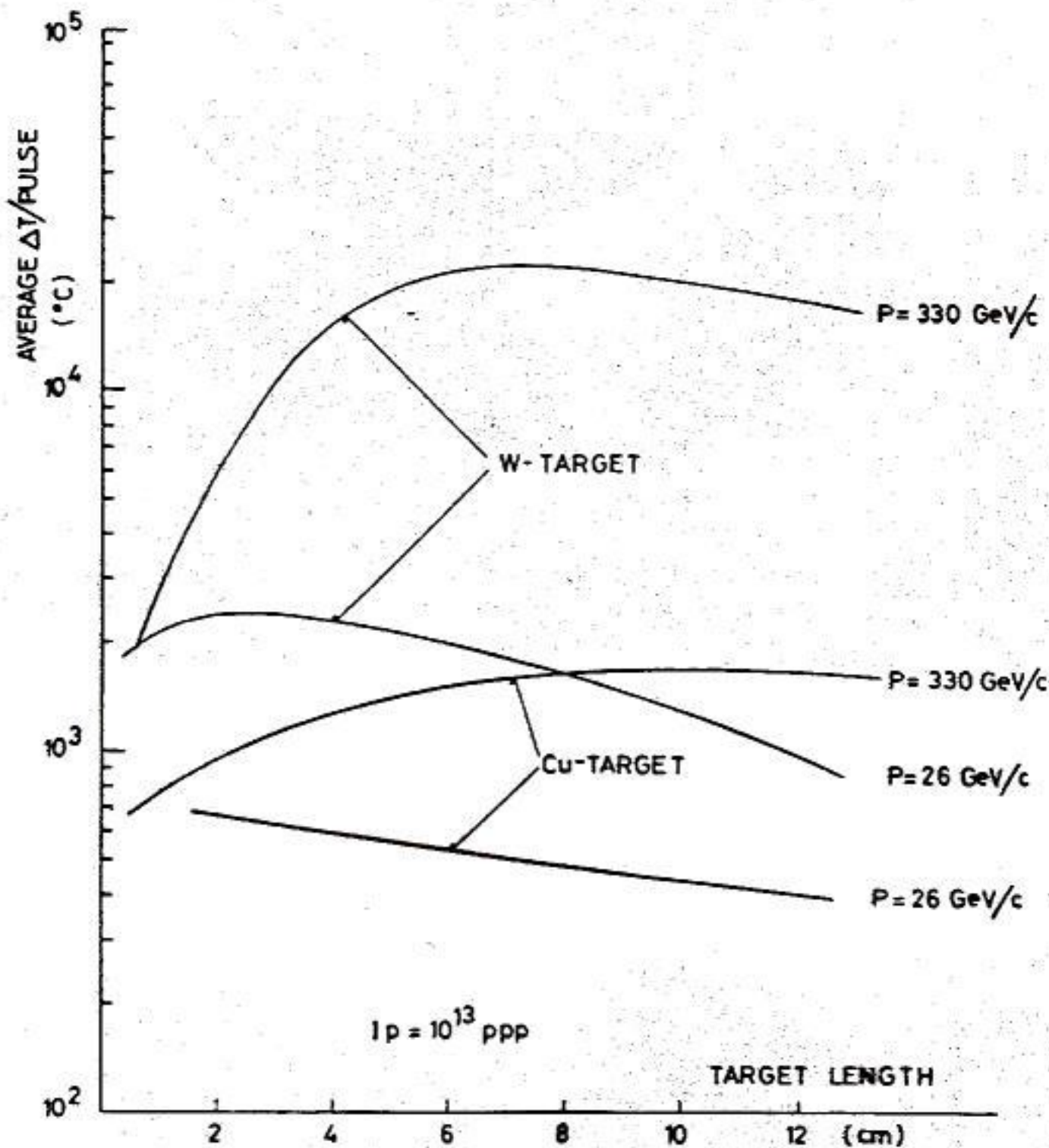

Fig. 3 - Temperatures rises per pulse due to 10^{13} protons of 26 GeV/c and 330 GeV/c in W and Cu targets. ΔT gives the temperature averaged over the target cross-section of 2 mm diameter.

46 = 1.2 mm

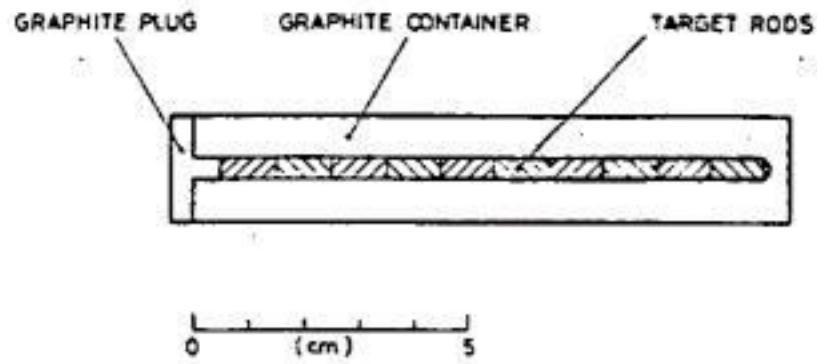

Fig. 1 - Vertical cut through the target graphite ensemble. The individual target rods are inserted into the blind axial hole, drilled into the graphite which is thereafter closed with a graphite plug.

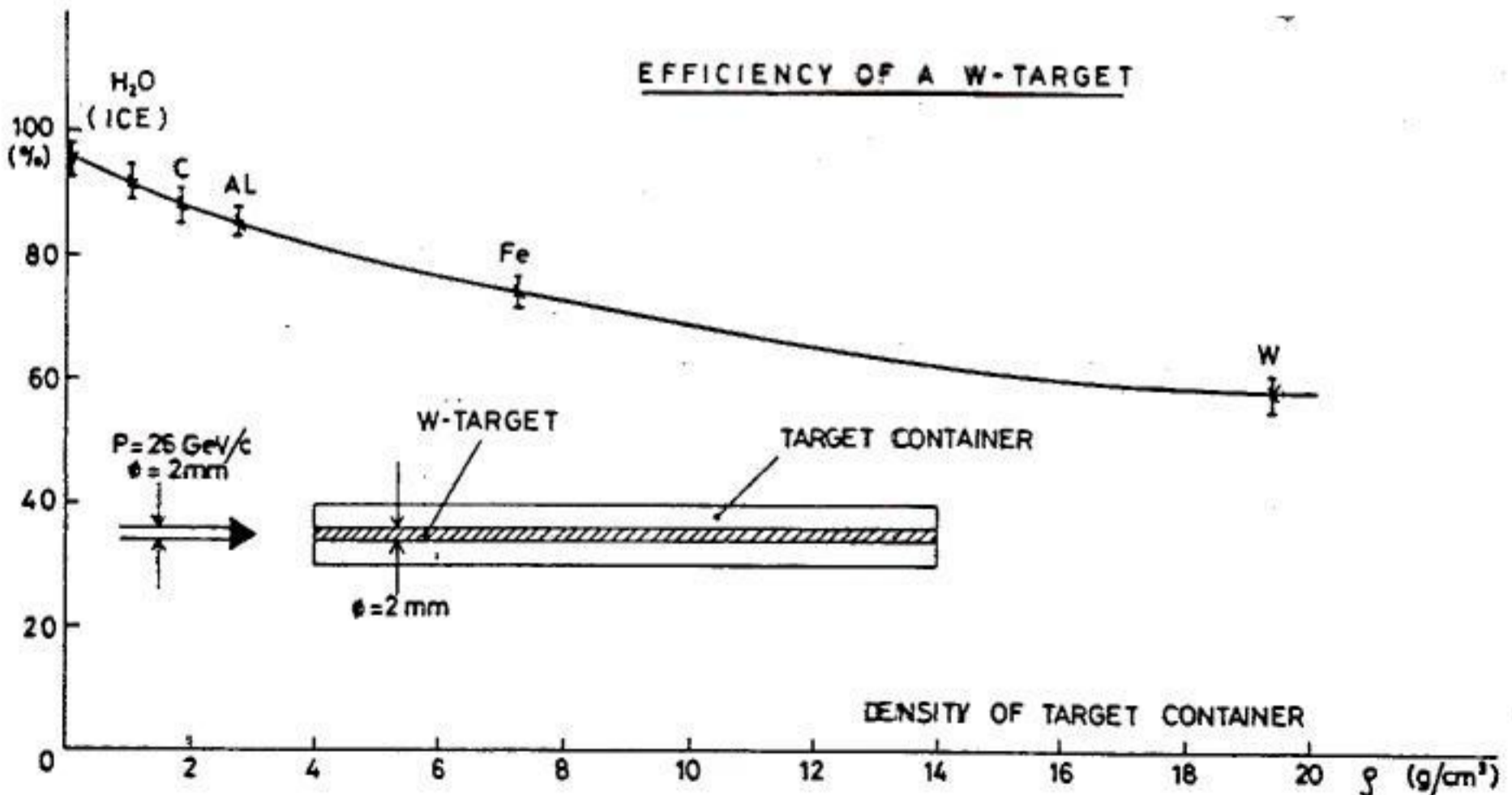
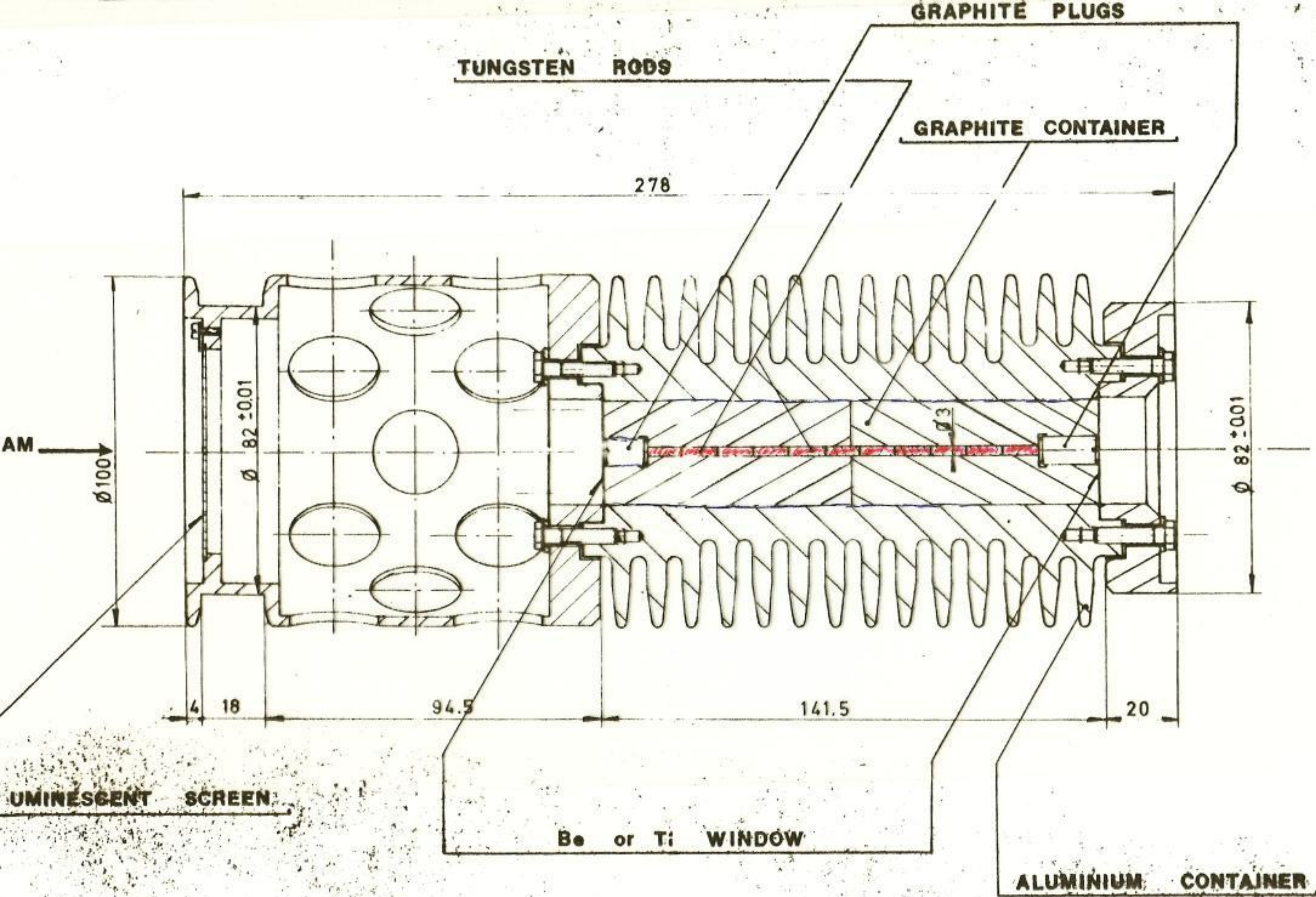
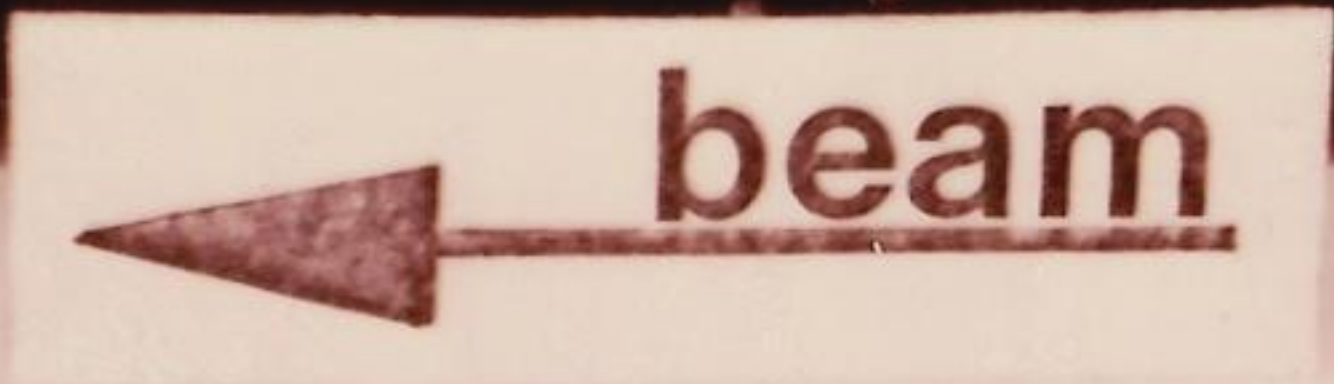
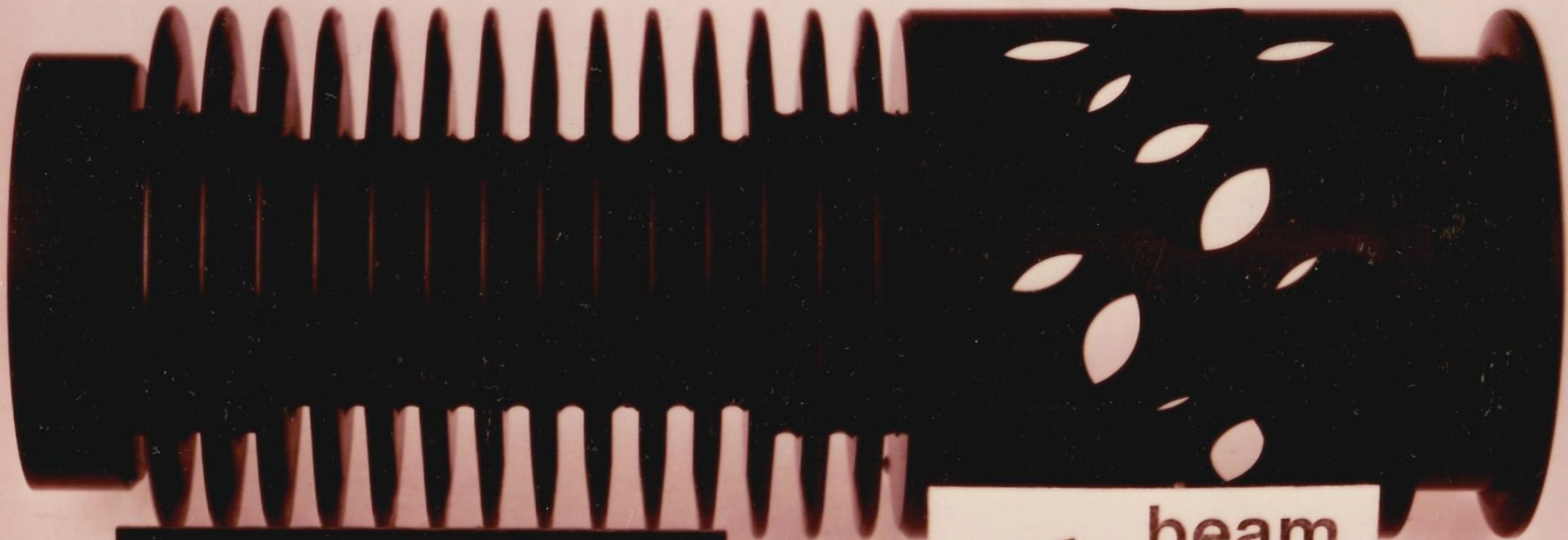
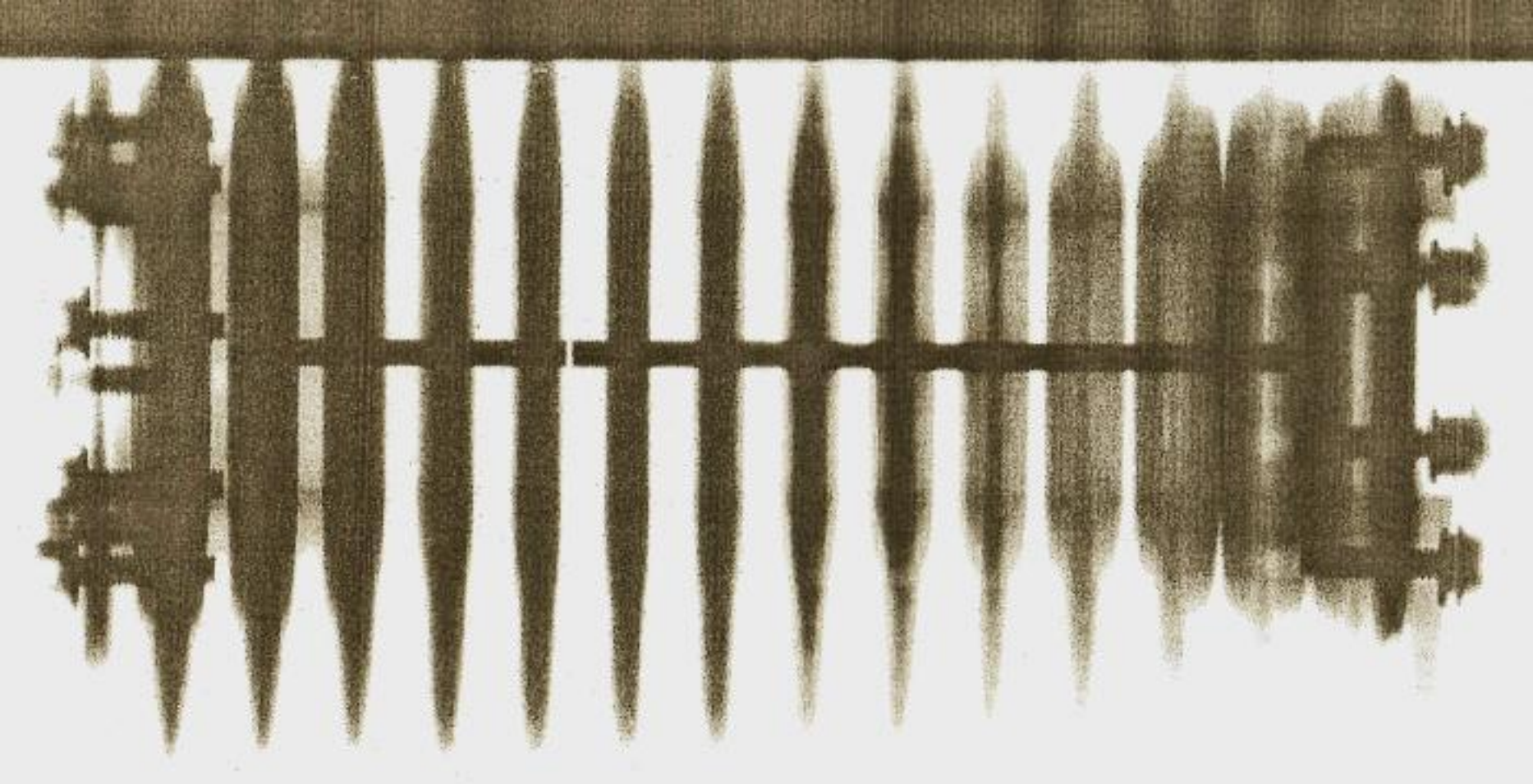

Fig. 2 - Target efficiency (escaping \bar{p} 's over created \bar{p} 's) of a 2 mm thick W target embedded in various materials. \bar{p} 's of 3.7 GeV/c produced within a cone of ± 50 mrad are considered.







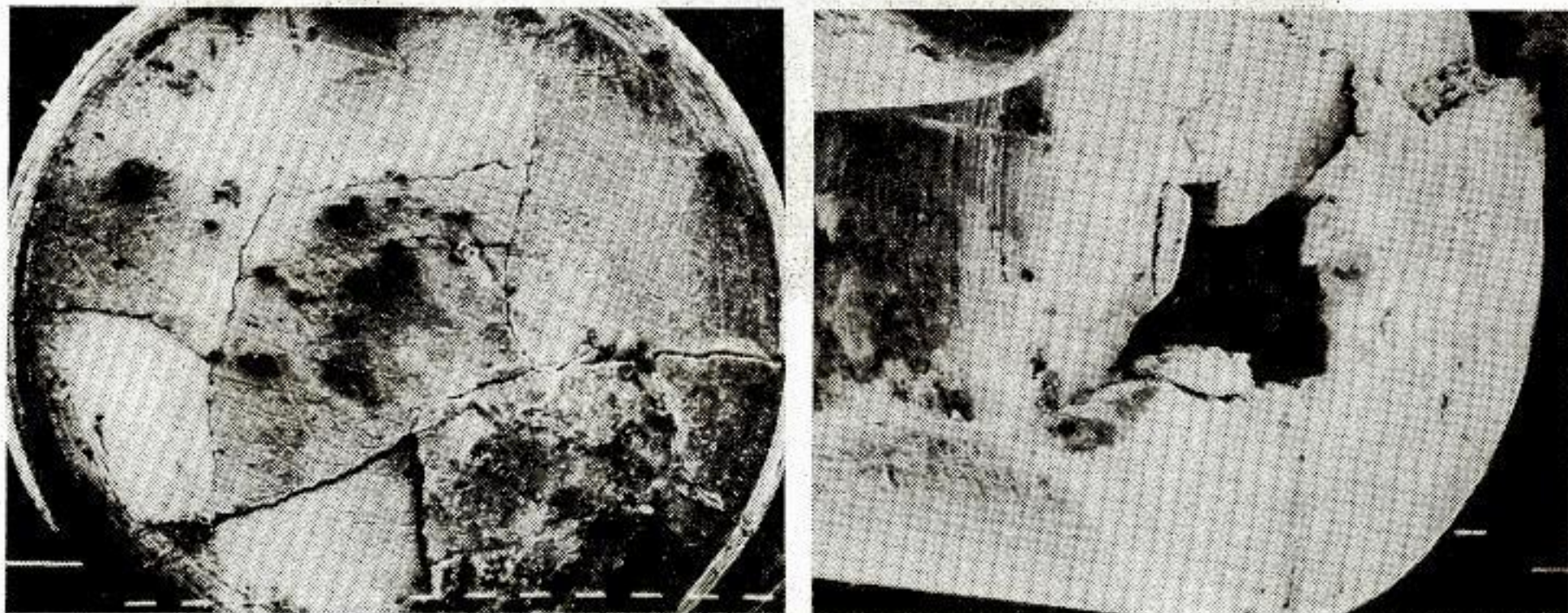

Fig. 7 - Front view of the W-rods after irradiation. The longitudinal cracks and a pit of about 1 mm depth can clearly be seen.

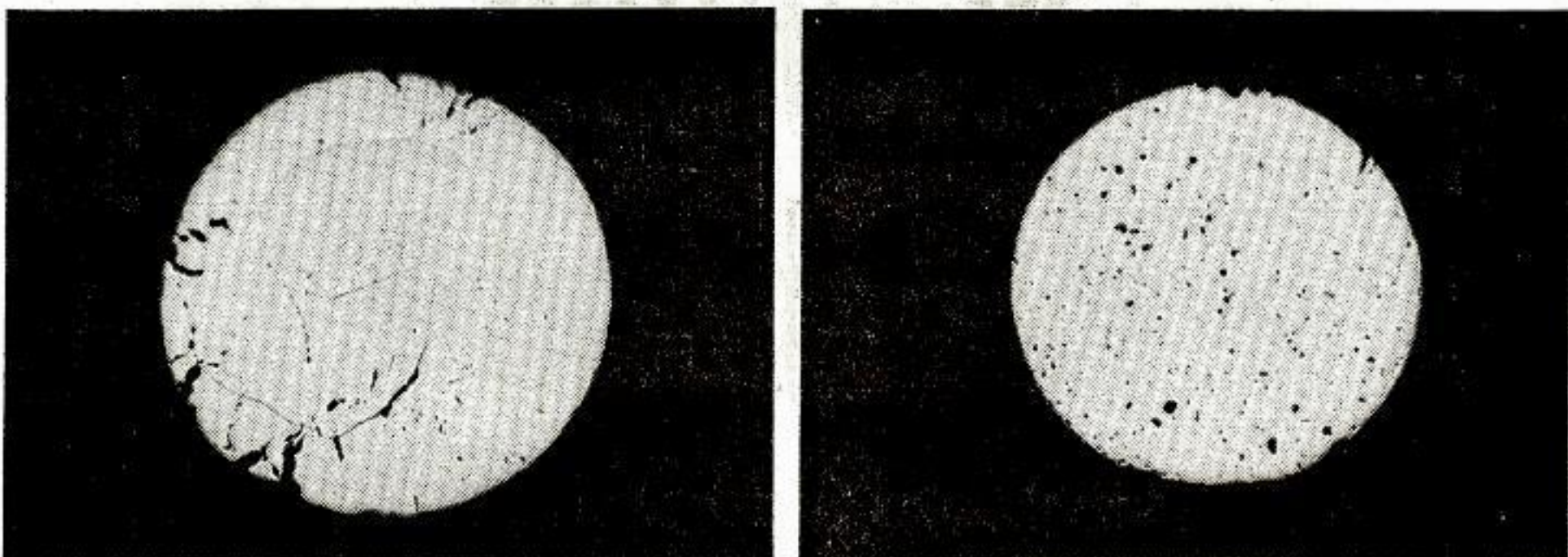
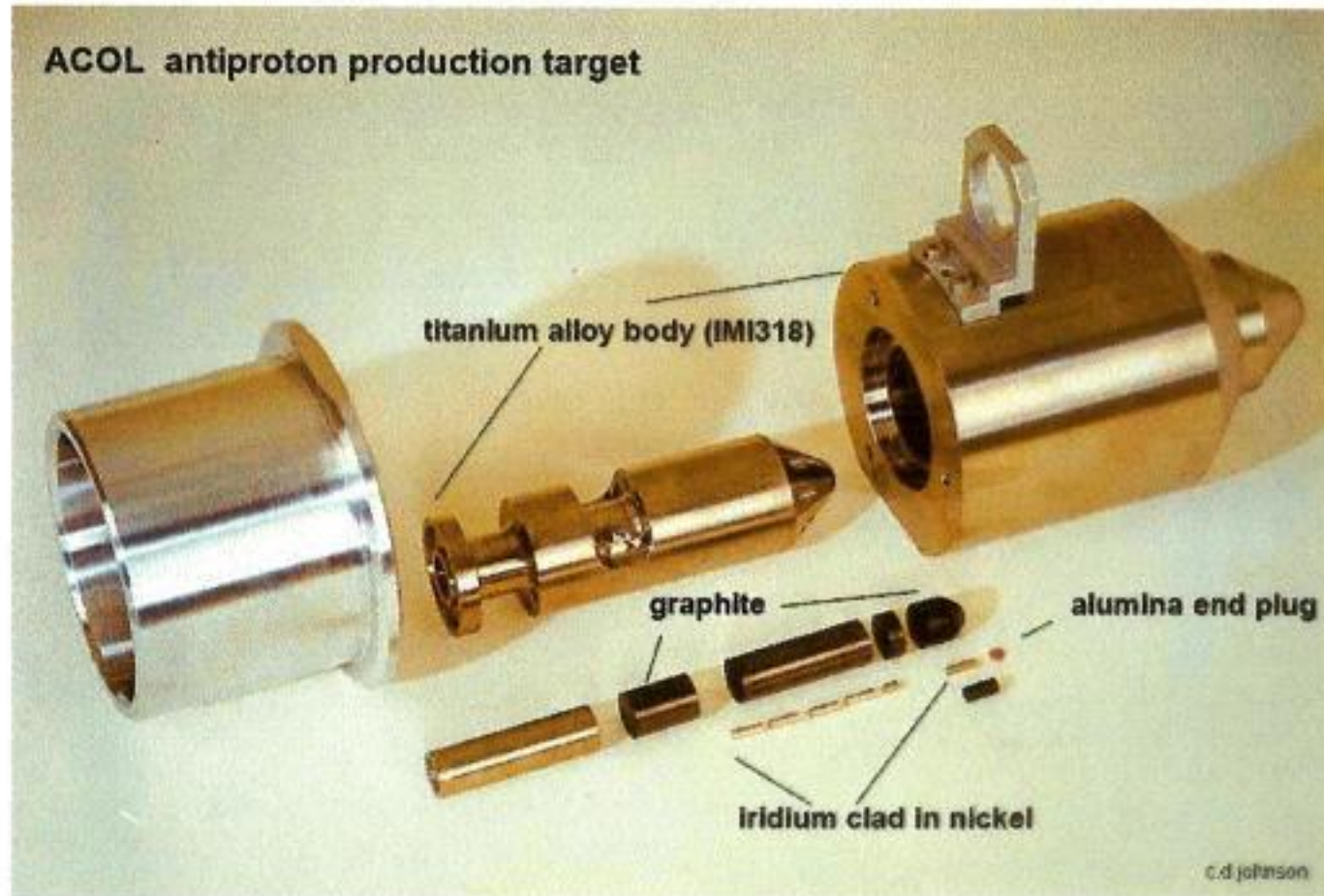

Fig. 8 - Tungsten (left) and rhenium (right) rods after bake-out in graphite at 2000° C over 48 hours. In the tungsten a considerable amount of tungsten carbide was formed. In the otherwise stable rhenium, a slight graphite precipitation occurred at the grain boundaries.

Production Target : ACOL-Target for FAIR?



Proposed:

ACOL target for FAIR up to 50% p-intensity

Arguments:

Should withstand beam period of 2-3 months

Simple construction

Not too expensive

Easy exchange (coolant connections only)

ACOL antiproton production target

Design issues:

Shock wave damage - radial acoustic impedance matching

Radiation induced voids - reduces density

Fatigue - container exit window at risk

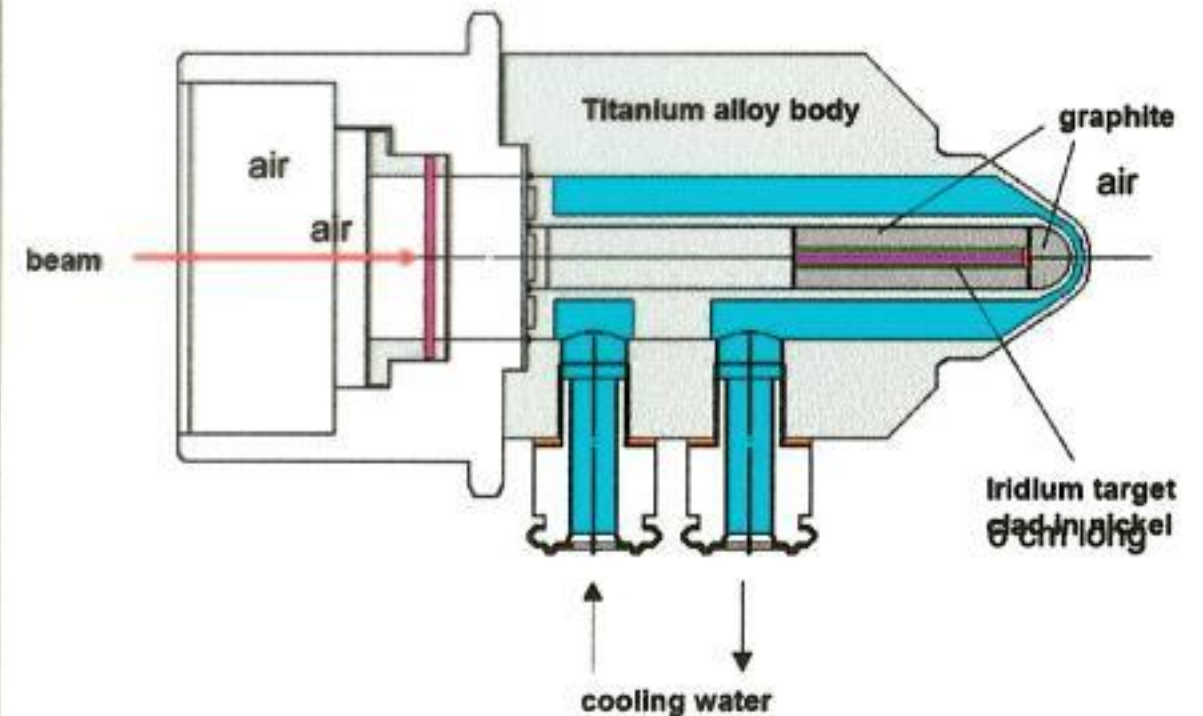

Collector: Magnetic Horn or Li-Lens

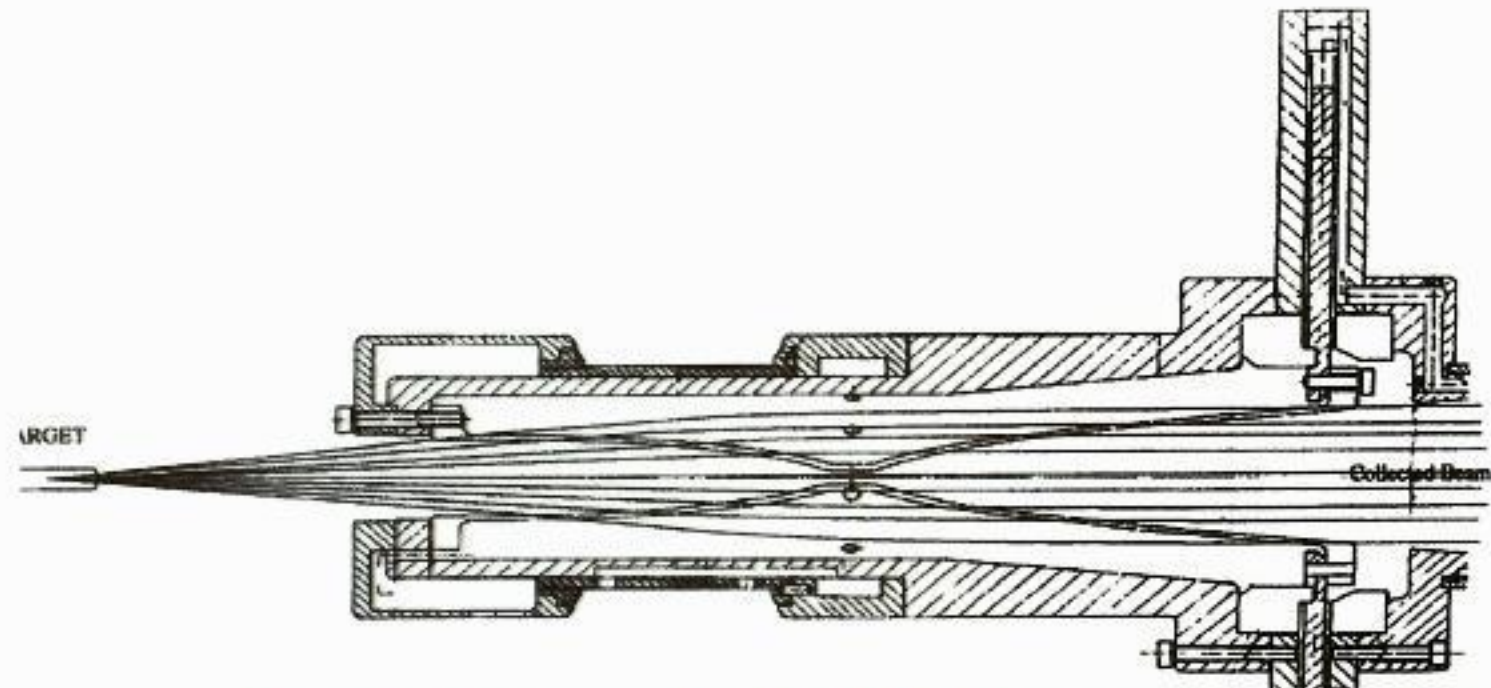
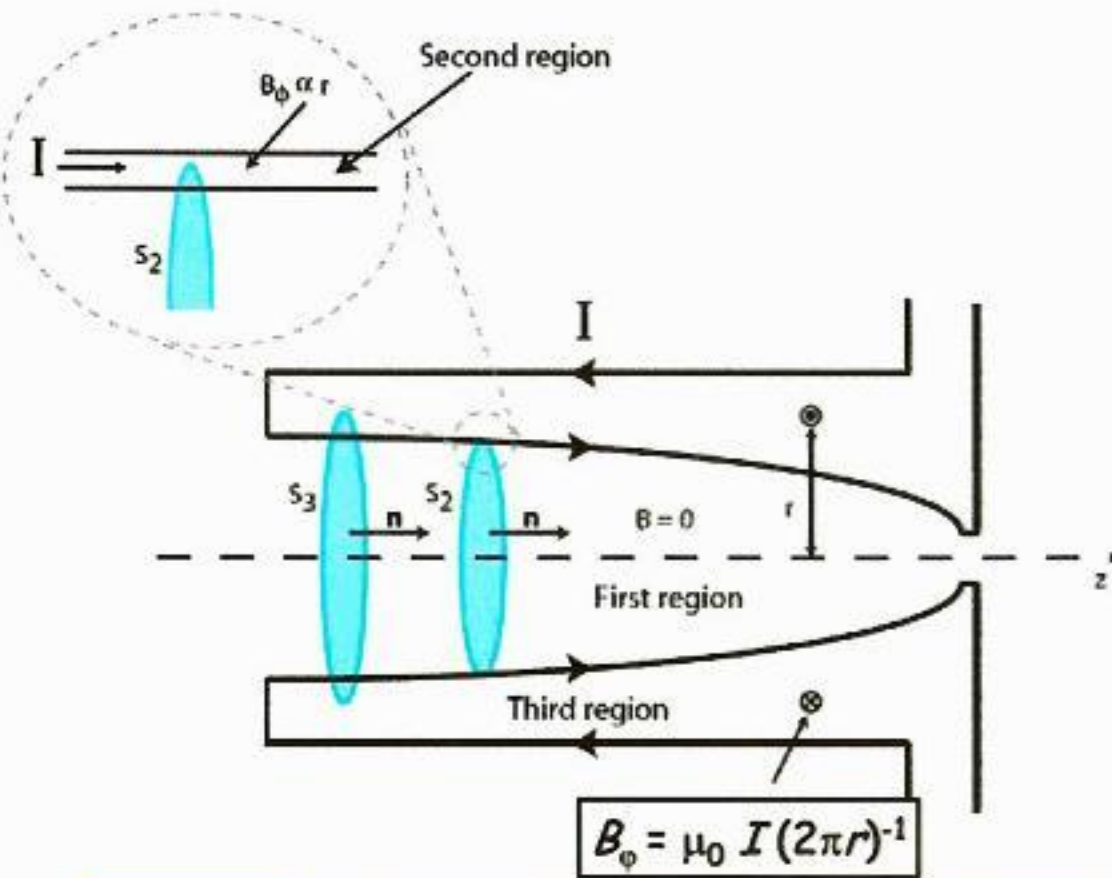

Proposed

Bi-conical ACOL-horn for FAIR (assembly drawing)

Operational parameters

Horn current	400 kA
Rise time	15 μ s
Acceptance angle for pbars	82 mrad
Manufacturing costs per unit:	30 000 €
5 units recommended	
(R. Maccaferri, CERN, private communication, July 2005)	

Proposed upgrade for 100% proton intensity:

3cm \varnothing Li-lens with 1 MA pulser

Operational parameters

Current	1 MA
Rise time	1 ms
Acceptance angle for pbars	95 mrad
Manufacturing costs per lens:	80 000 €
5 spare lenses recommended	
(P. Sievers, CERN, private communication, July 2005)	
1 MA pulser & transformer:	300 000 €
My own estimate!	

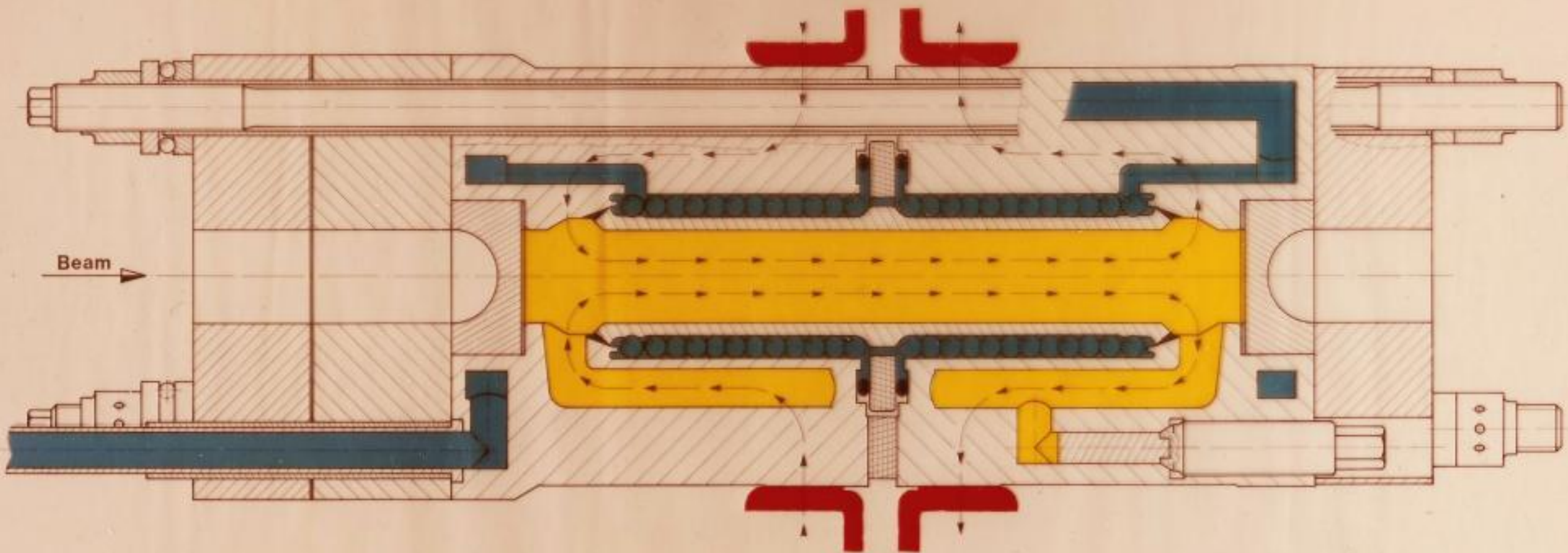



18. 7. 68

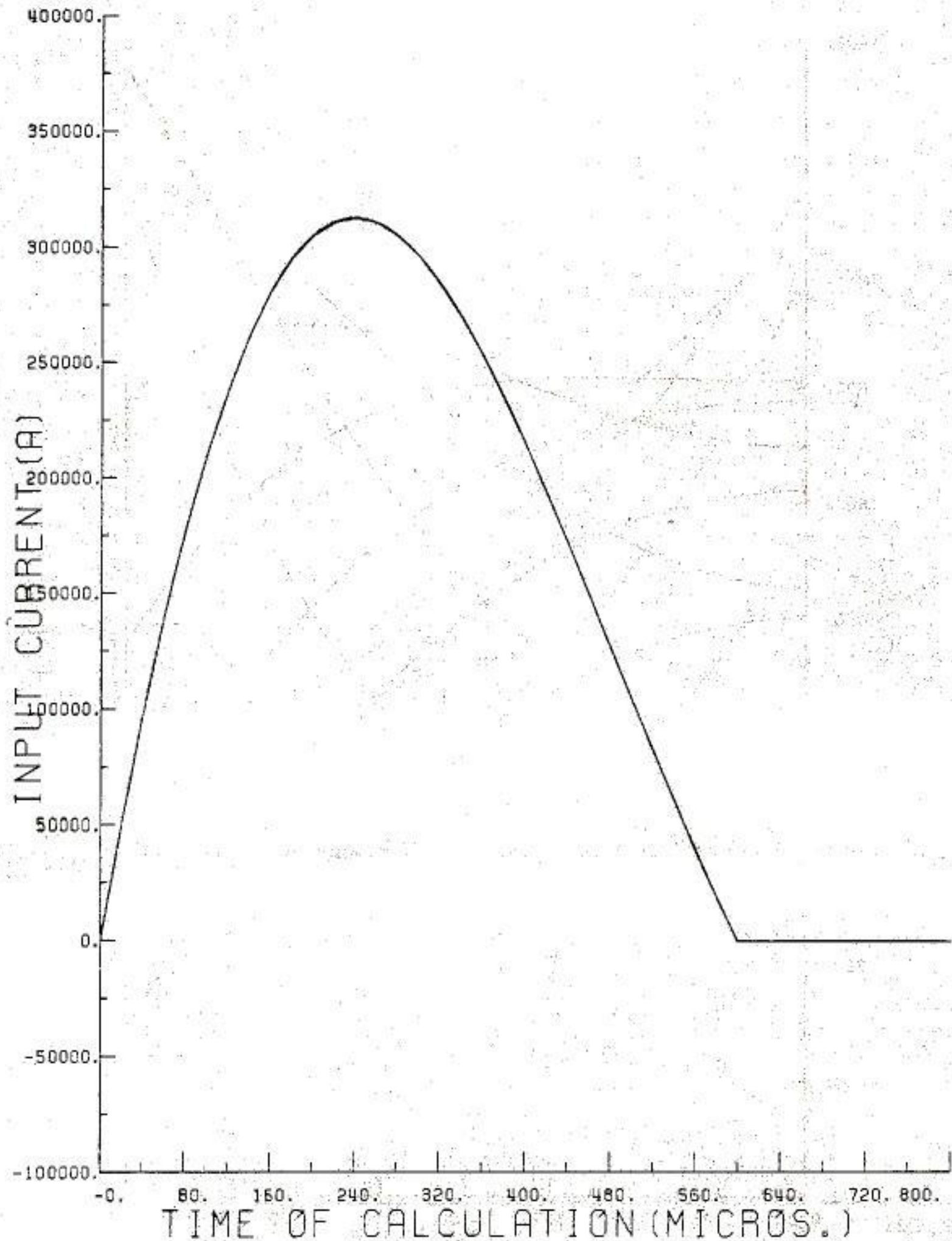

Fig.1. The current pulse.

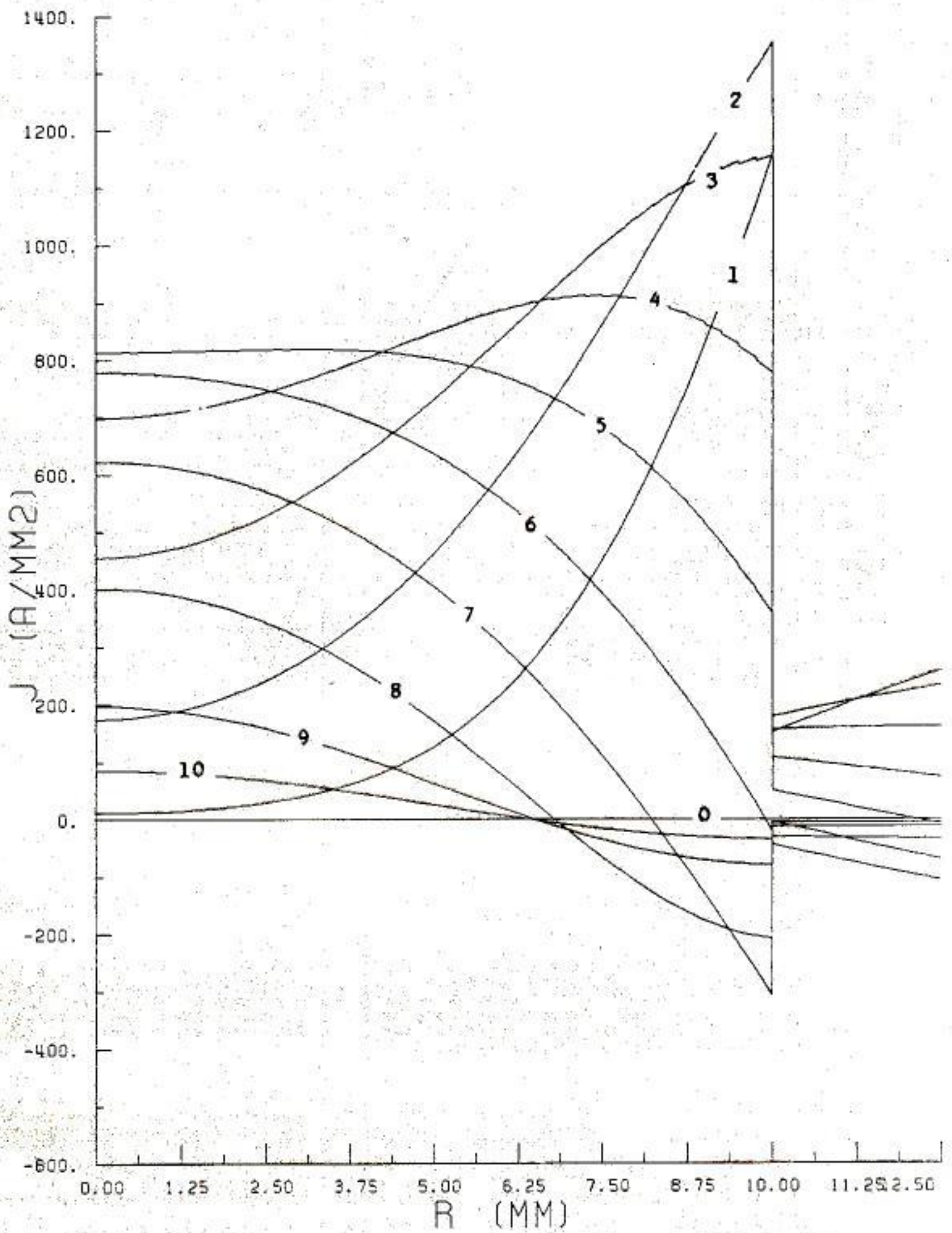

Fig.2. The current density distribution at various instants.
 The curves are marked with the number of time increments
 of 80 microseconds each.
 The driving current pulse is shown in fig.1.

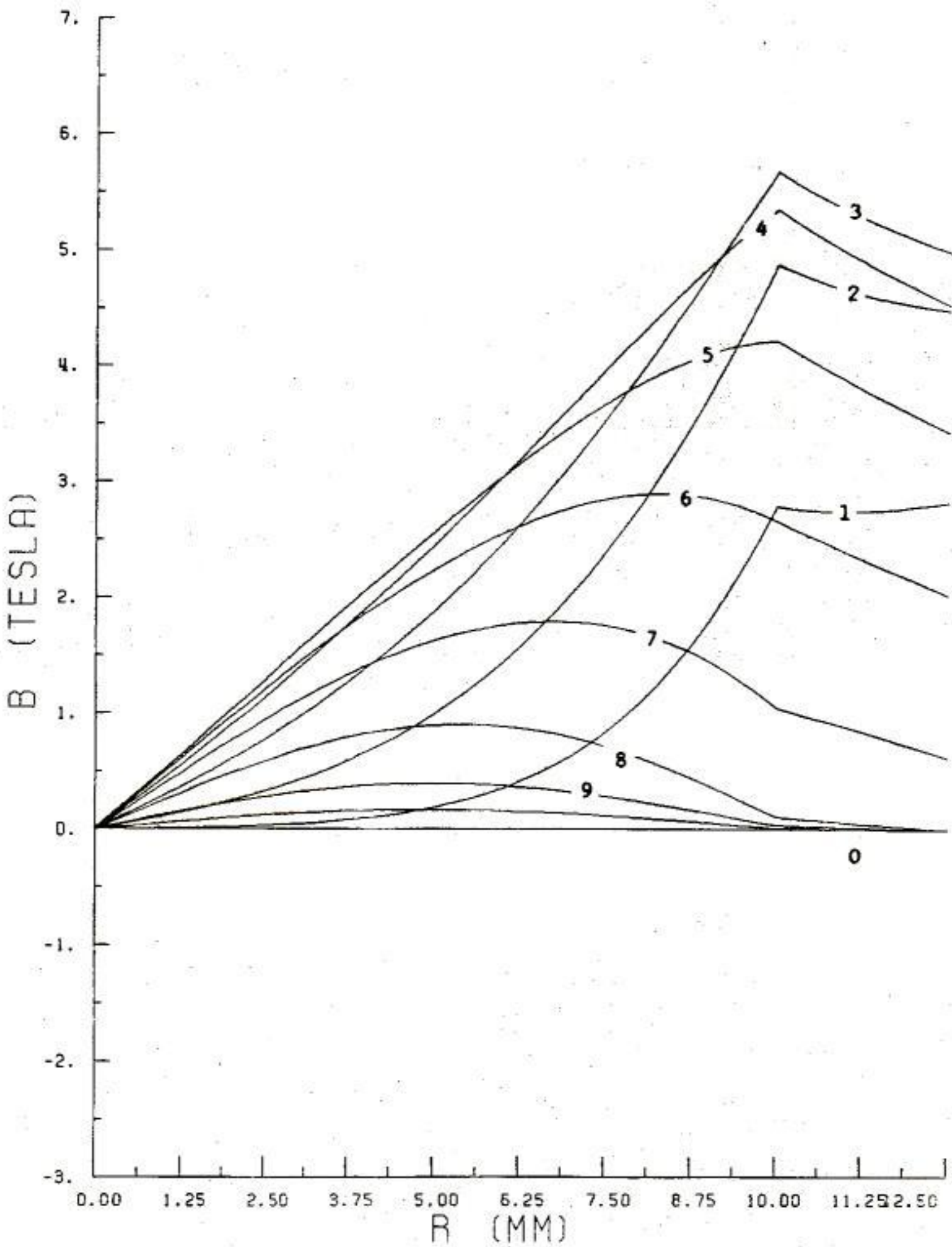

Fig.3. The field distribution at various instants.
 The curves are marked with the number of time increments of 80 microseconds each.
 The driving current pulse is shown in fig.1.

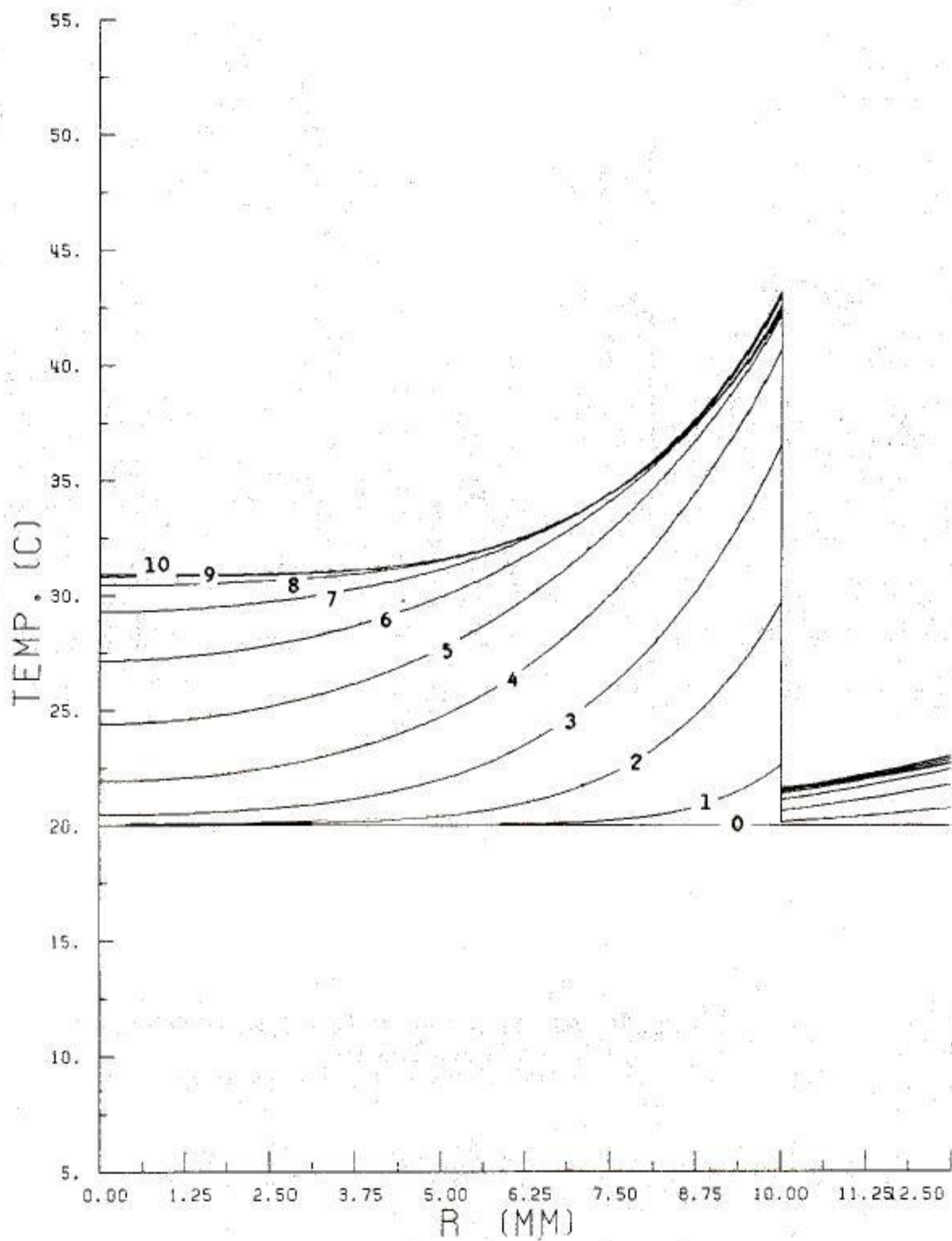
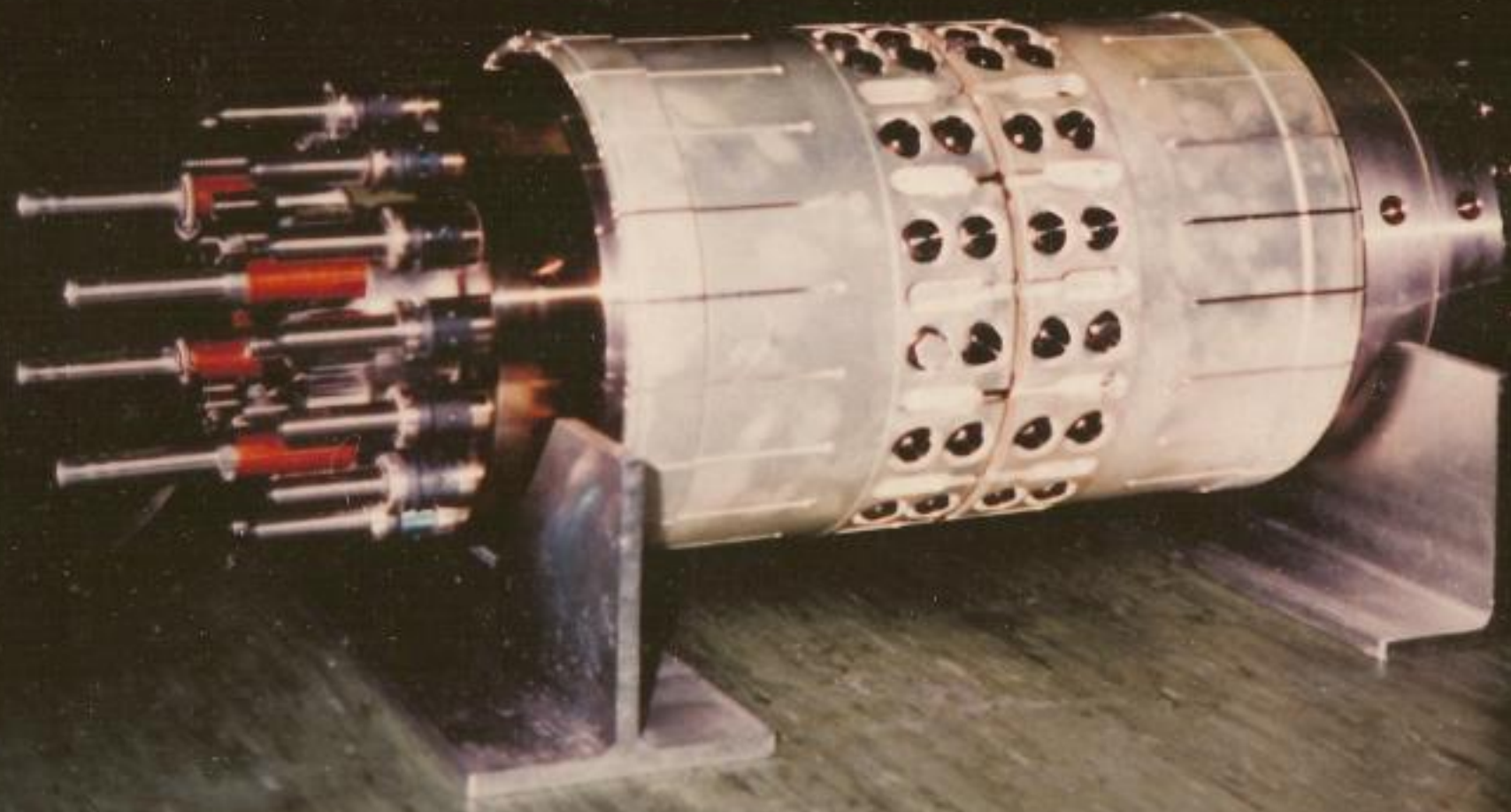

Fig.5. The temperature distribution at various instants during a single pulse.
 The curves are marked with the number of time increments of 80 microseconds each.
 The driving current pulse is shown in fig.1.



x846 .9.86



306.1.89



NOVOSIBIRSK-CERN

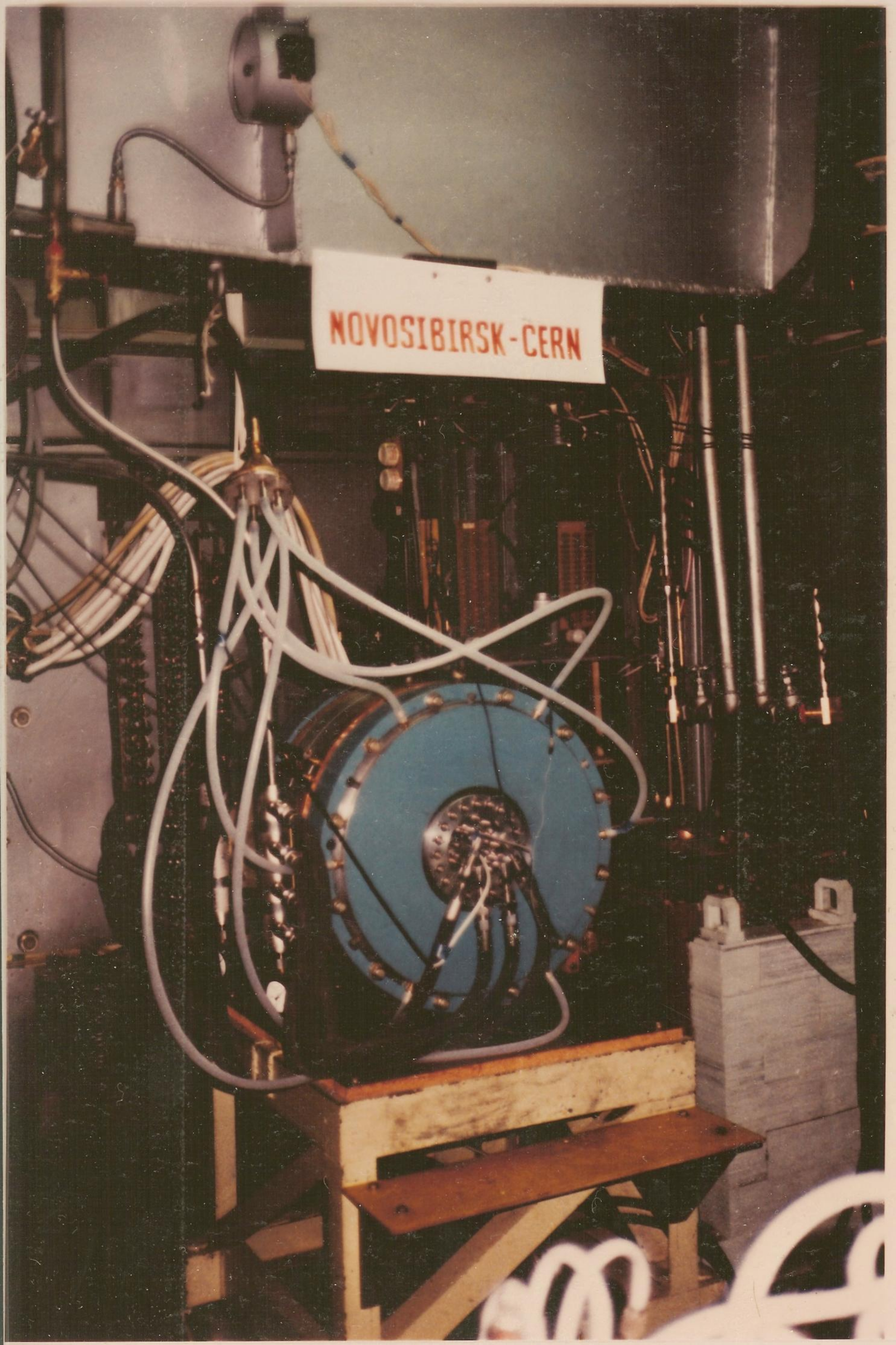

ANTI-PROTON ACCUMULATOR

1986

Performance to date - Spring 1982

	Operational	Best	Design Goal
1. Yield = $\frac{\text{No. of } \bar{p}'\text{s circulating on injection orbits}}{\text{No. of } p'\text{s colliding with target}}$	6×10^{-7}	7.8×10^{-7}	$25 \times 10^{-7}^*$
2. Acceptance on injection orbits: Horizontal E_H Vertical E_V Longitudinal $\Delta p/p$	60 π 70 π >1.5 $\times 10^{-2}$	89 π 75 π >1.5 $\times 10^{-2}$	100 π (mm.mrad) 100 π (mm.mrad) 1.5 $\times 10^{-2}$
3. Precooling Efficiency = $\frac{\text{No. of } \bar{p}'\text{s captured and transferred by RF}}{\text{No. of } p'\text{s circulating on injection orbits}}$	67%	75%	80%
4. Stacking Efficiency = $\frac{\text{No. of } p'\text{s circulating in the stack}}{\text{No. of } p'\text{s captured and transferred by RF}}$	60%	67%	84%
5. Accumulator efficiency = (#3 \times #4)	40%	50%	67%
6. Accumulation Rate: (\bar{p} 's per hour; *normalized to AA receiving 6 PS cycles out of 6, each cycle delivering $\sim 10^{13}$ protons)	$3.5 \times 10^9/h$	$\sim 5 \times 10^9/h$	$25 \times 10^9/h^*$
7. Missing Factor: MF = $\frac{\text{Design Goal \#6 (optimistic value)}}{\text{Operational or Best \#6}}$	7.1	~ 5	1
8. Stack Density (after ~ 30 min cooling without accumulation)	$2.4 \times 10^{10} \bar{p}/eVs$	$5.4 \times 10^{10} \bar{p}/eVs$	$12 \times 10^{10} \bar{p}/eVs$
9. A maximum circulating current of	$10^{11} \bar{p}'s$	$1.9 \times 10^{11} \bar{p}'s$	$\sim 10^{12} \bar{p}'s$
10. "Cooled" emittances: (after 30 min without accumul.) 95% values	Horizon. E_H 1.2 π Vertical E_V 1.6 π Longit. $\Delta p/p$ 3×10^{-3}	1 π 0.9 π 3×10^{-3}	1.4 π (mm.mrad) 1 π (mm.mrad) 3×10^{-3}
11. Eject. Efficiency = $\frac{\text{No. of } \bar{p}'\text{s arriving at PS at 3.5 GeV/c}}{\text{No. of } \bar{p}'\text{s leaving AA at 3.5 GeV/c}}$	>85%	>95%	100%

focused and matched into the injection transport line by a collector lens. Different collectors have been successfully used:

- a lithium lens of 20 mm diameter, pulsed with 480 kA excitation current,
- a lithium lens of 34 mm diameter, pulsed at 1.0 MA,
- a magnetic horn of 60 mm diameter, pulsed at 400 kA.

Two other types of collectors were tested in situ:

- a lithium lens of 36 mm diameter, pulsed at 1.2 MA [6],
- a plasma lens of 40 mm diameter, pulsed at 400 kA [7].

The performance of the different devices is illustrated in Fig. 1. For routine operation the magnetic horn is the preferred solution, as it seems to be very reliable and less expensive to build. These advantages largely override the slightly smaller yield.

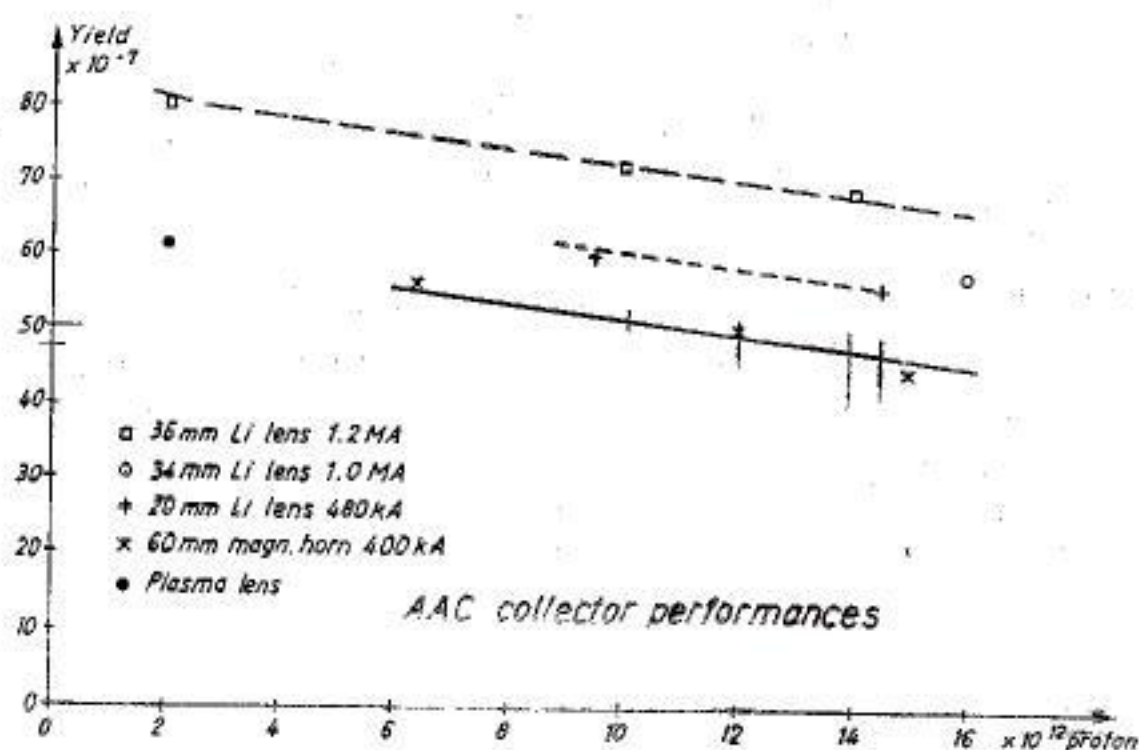

Fig. 1.

4. AC injection yield

With careful adjustment, the AC reaches (and even exceeds) the design acceptances (Table 1). This leads to efficient capture of the incoming beam.

Table 1

		Design values	Reached values
A_h	(π mm-mrad)	200	220
A_v	(π mm-mrad)	200	210
$\Delta p/p$	(%)	6	6

2.6	80.0	+38
10.0	72.1	+24
14.0	69.1	+19

In the last column we see the yield increase compared to the 20 mm lithium lens ($Y_0 = 58 \times 10^{-7} \bar{p}/p$). The yield measurement comparison between 20 mm and 36 mm Li lens is plotted in Fig. 4

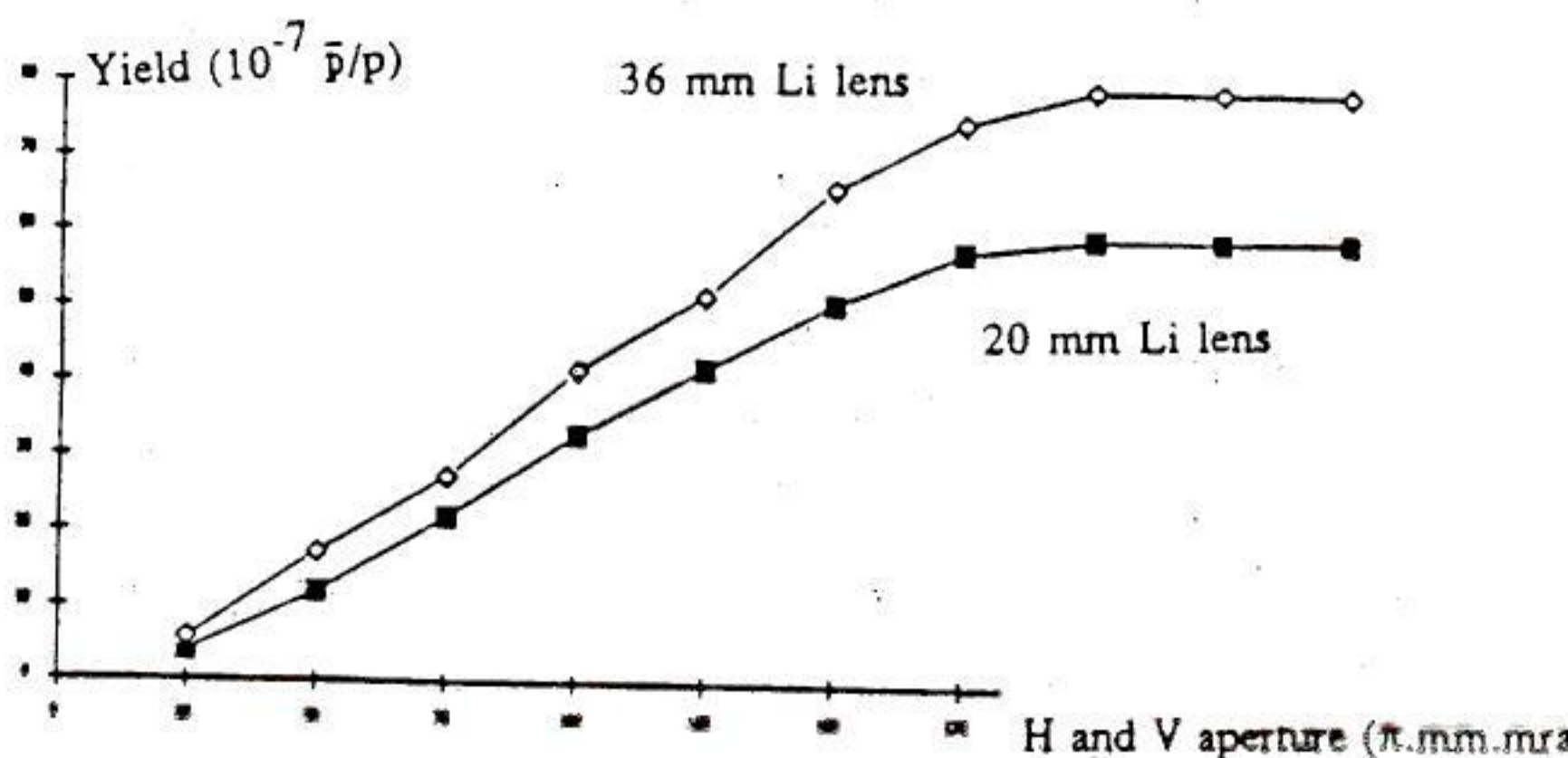

Fig. 4 - Yield comparison between 20 and 36 mm lithium lens.

The maximum number of antiprotons injected into the AC was 9.5×10^7 (mean value over ten pulses). It should be fairly easy to reach a value of 10^8 antiprotons after further adjustment.

Lithium Lens Lifetime and Improvement

During subsequent life tests in the laboratory, the stainless steel container of the lithium lens failed after half a million pulses at 1.1 MA. A substantial increase in wall thickness is obtained by reducing the lithium diameter from 36 mm to 34 mm. The resulting loss of yield is only about 3 to 4% according to the Monte Carlo program used in ref. [8]. It should be noted that the prototype 36 mm lens was originally designed for a peak current of 800 kA. Two new 34 mm lithium lenses are being built and should be tested and ready for operation in August 1990.

References

- [1] R. Bellone, A. Iispeert and P. Sievers, in

T 24

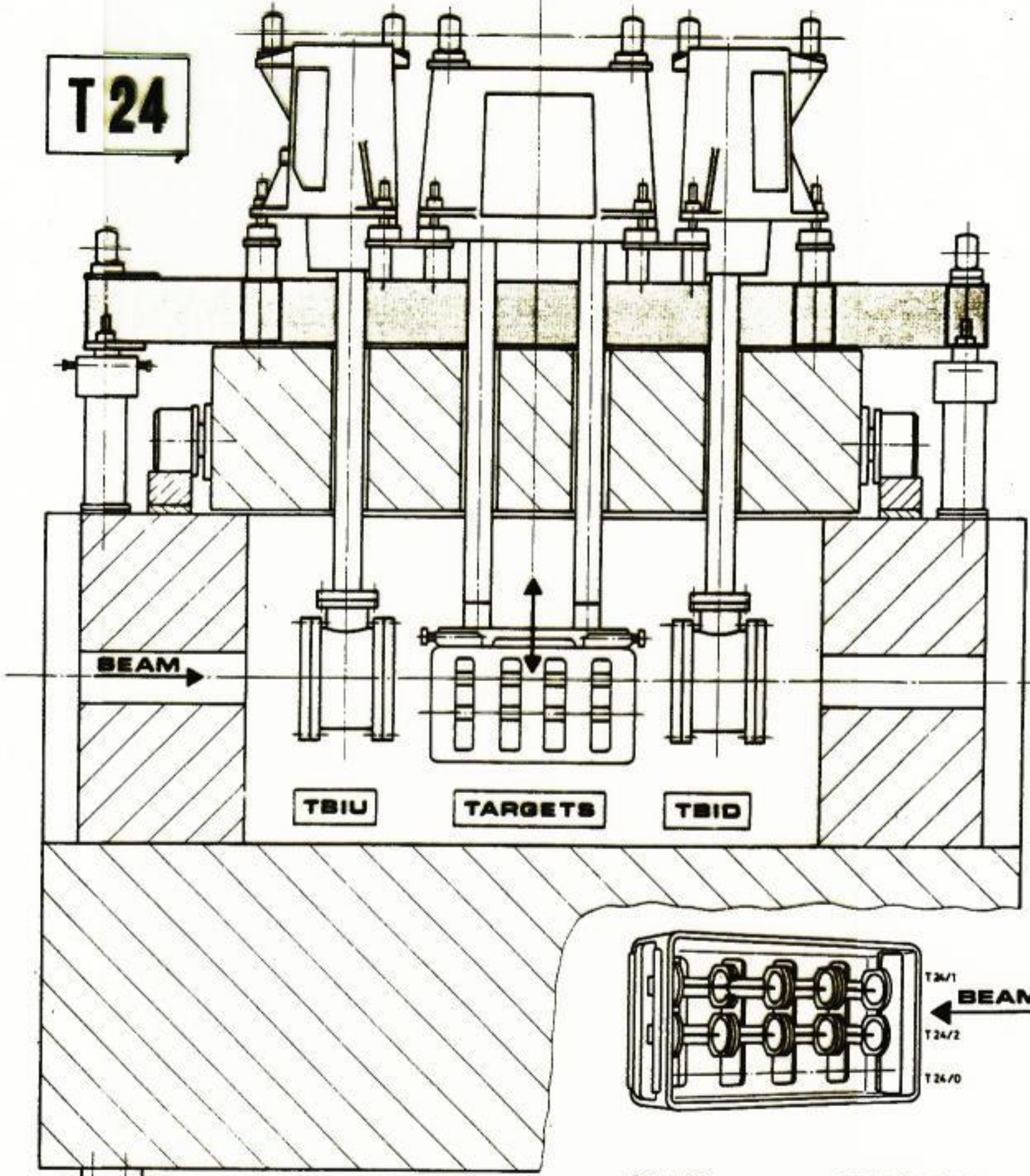

Echelle 0,2
0 100 200

8086.7200.1

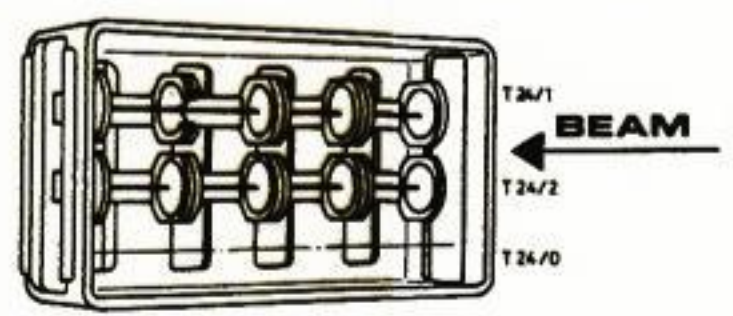

8086.7200.1	
LAYOUT SCHEMATIC	
1:5	
8086.7200.1	

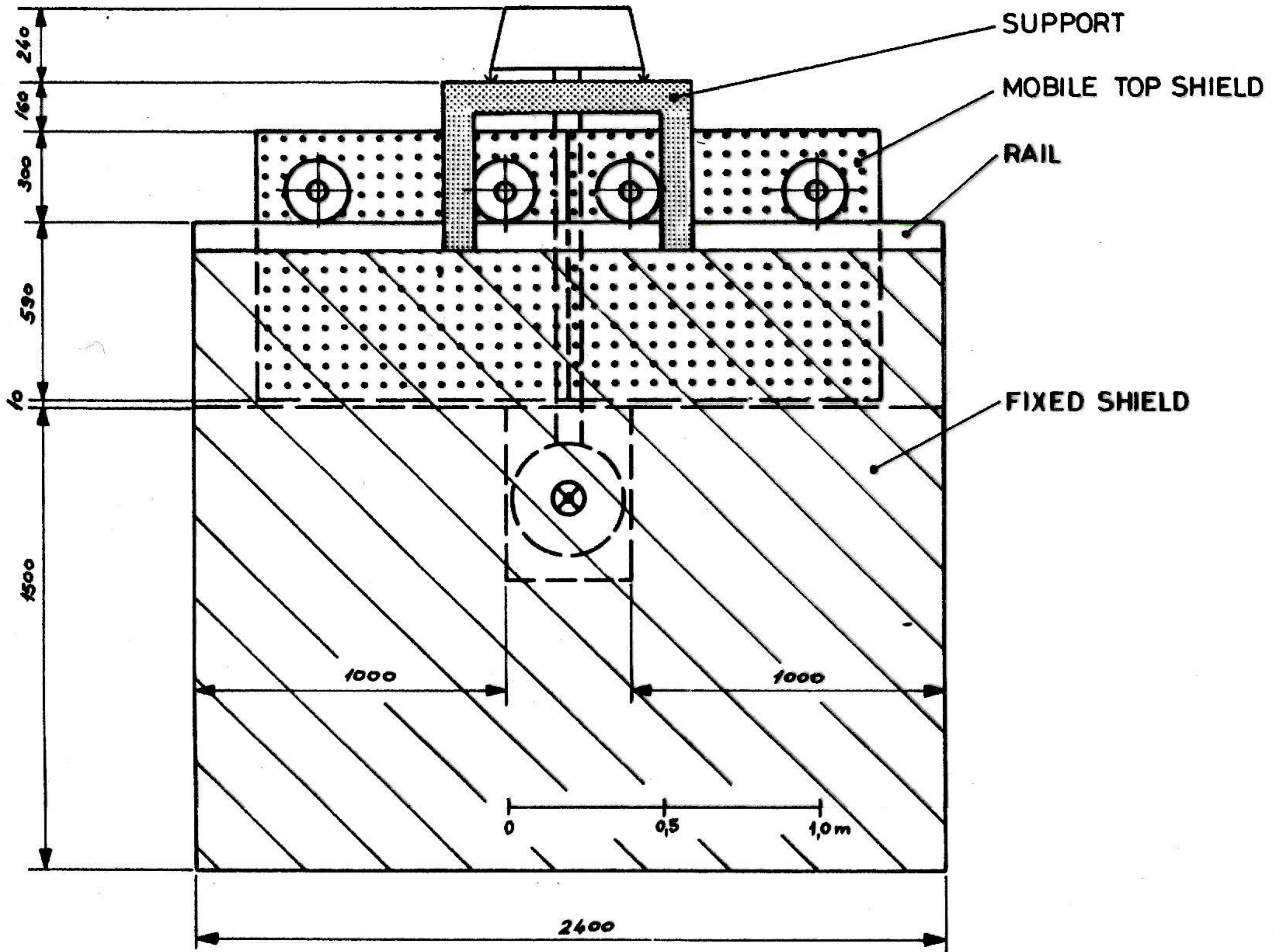

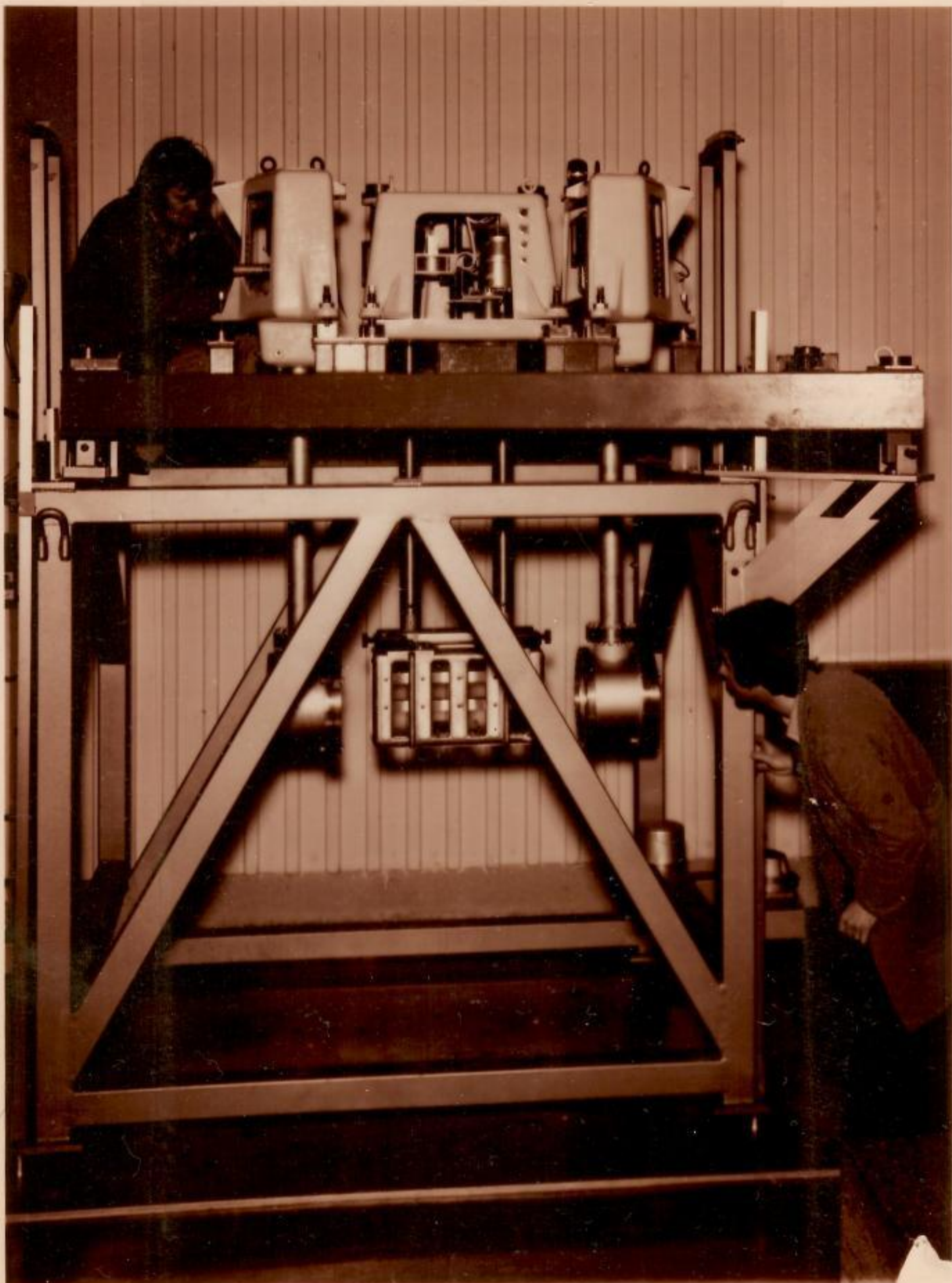

T8_T10

017.811

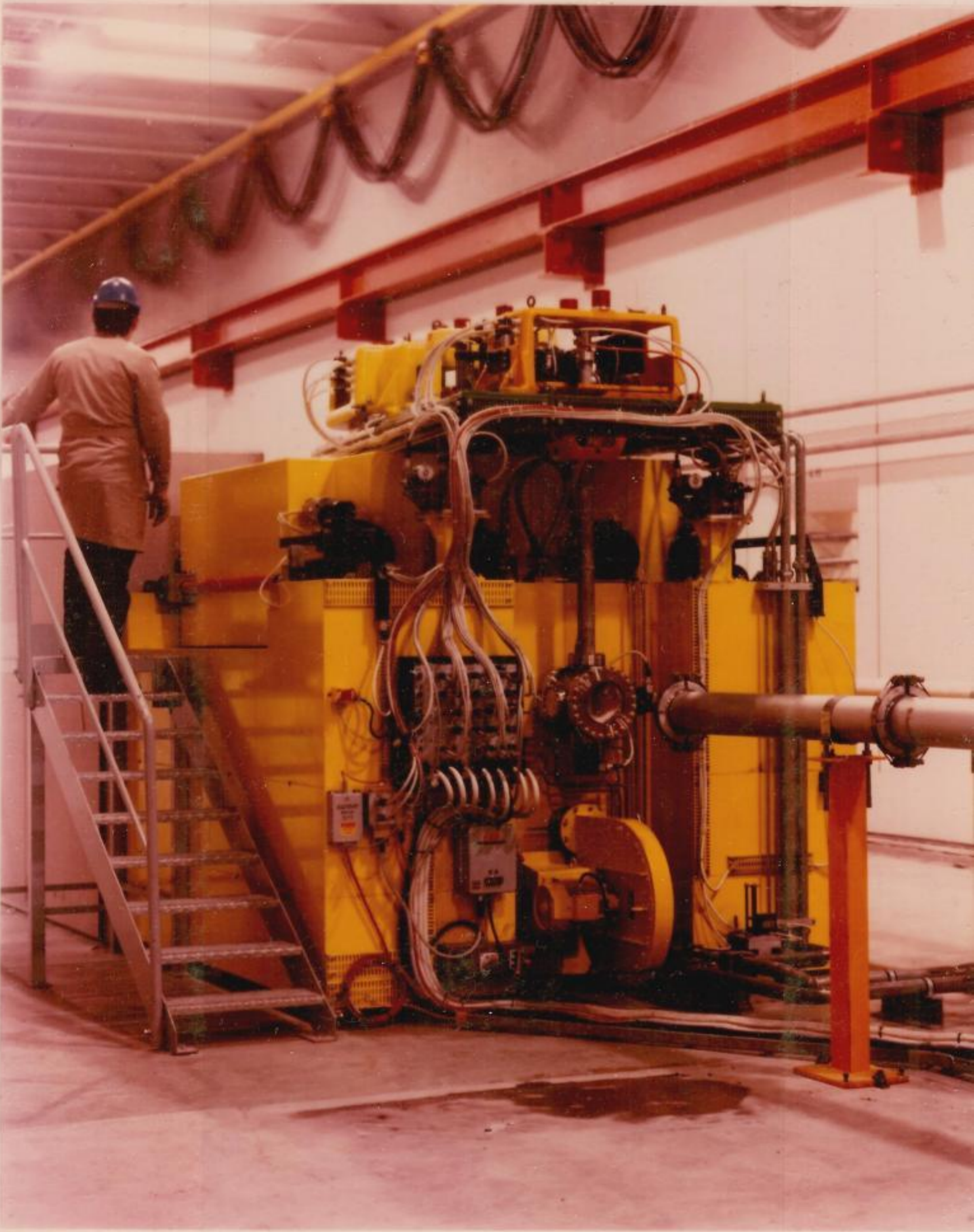

T8 . T10

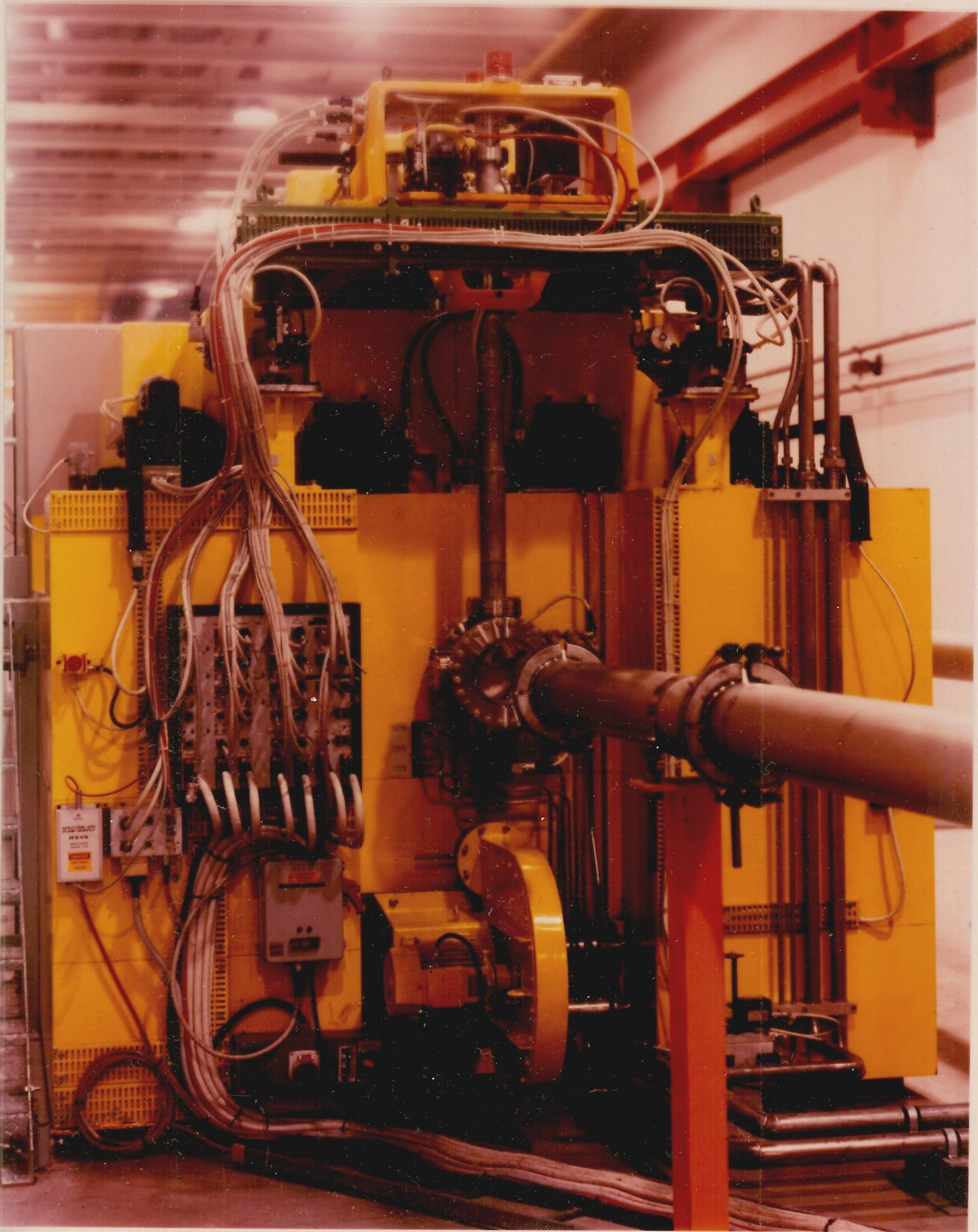

Réf: X 694 11-79

TARGET STATION "0"

P. STEUER
25/7/06

SIDE VIEW

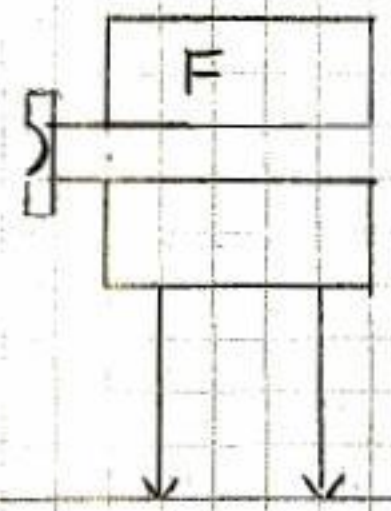
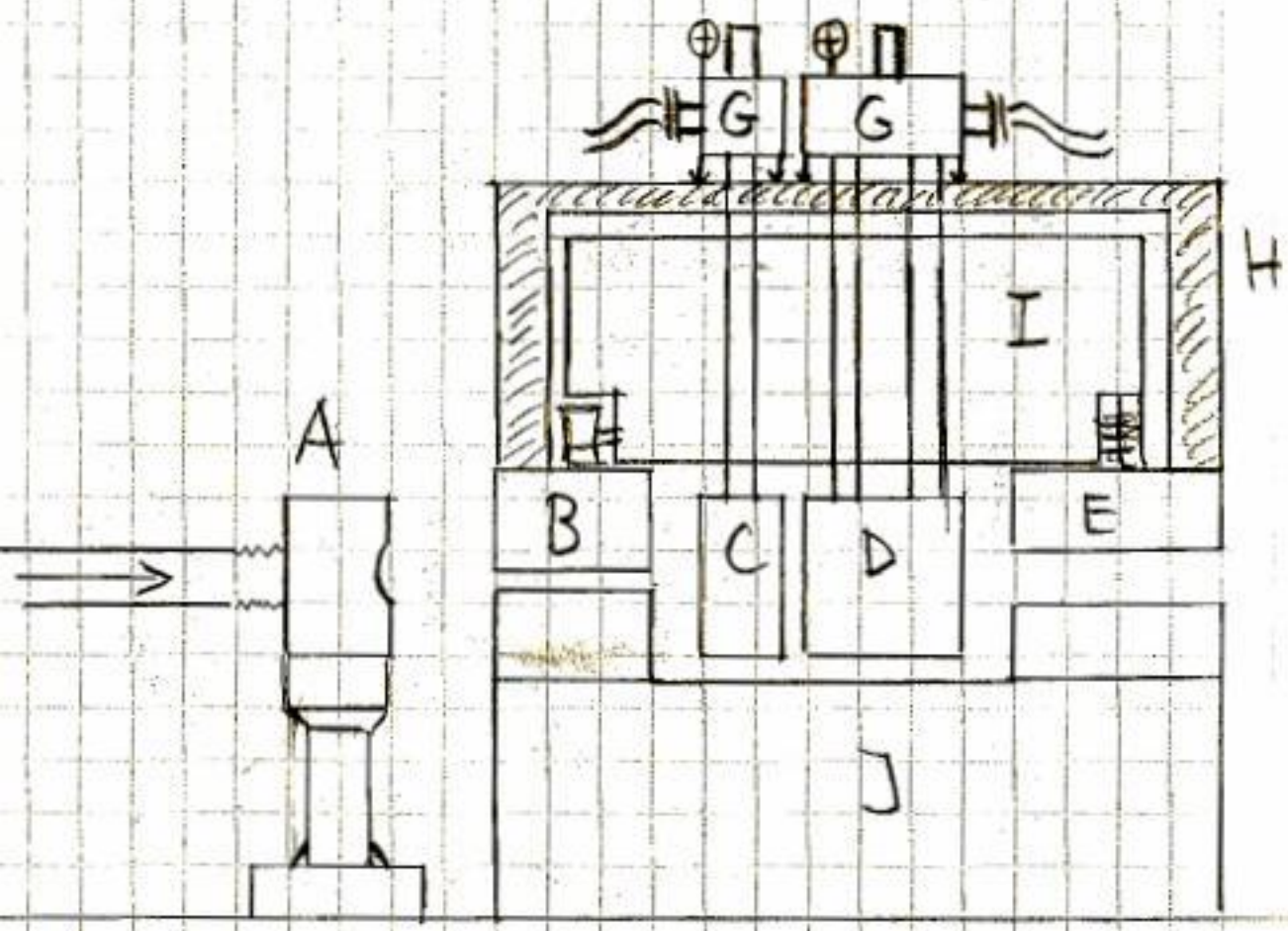

0 50 100 150 200 [cm]

SCALE

TARGET STATION "0"

P. SIEVERS

25/7/06

FRONT VIEW

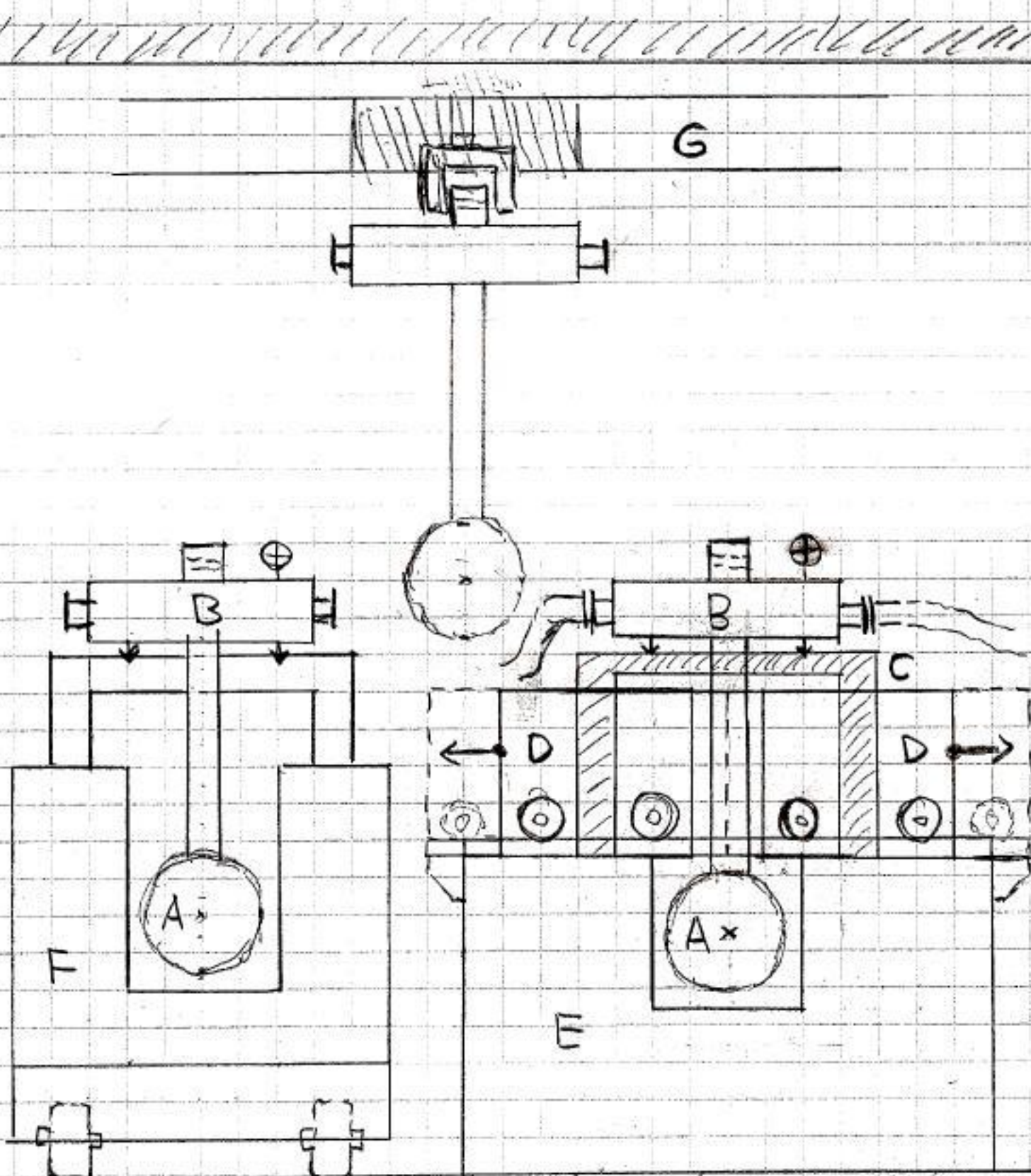

0 50 100 150 200 [cm]

SCALE

TARGET STATION "1"

P. SIEVERS
27/7/06

SIDE VIEW

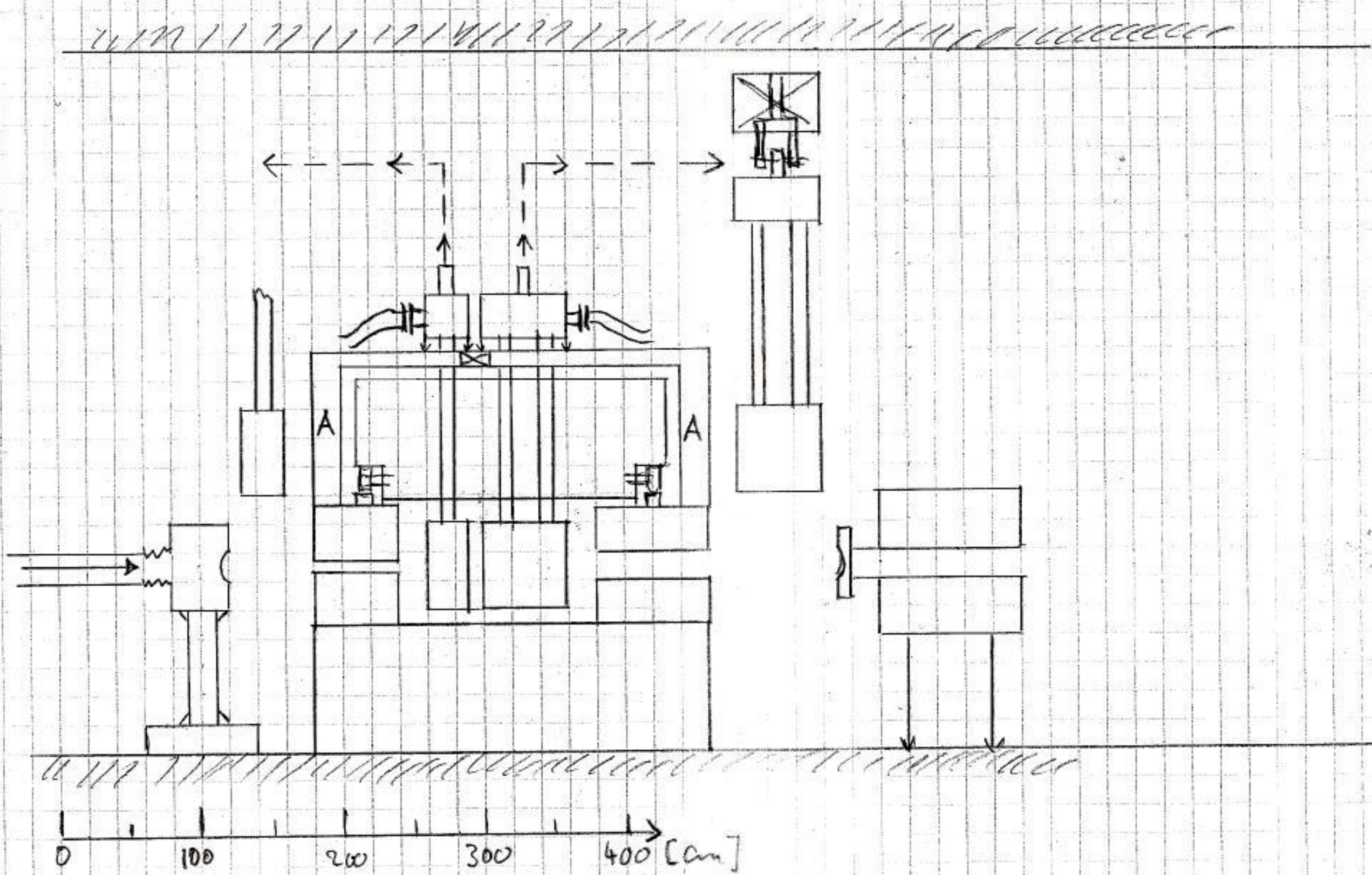

SCALE

0 100 200 300 400 [cm]

TARGET STATION "3"

7/8/06

FRONT VIEW

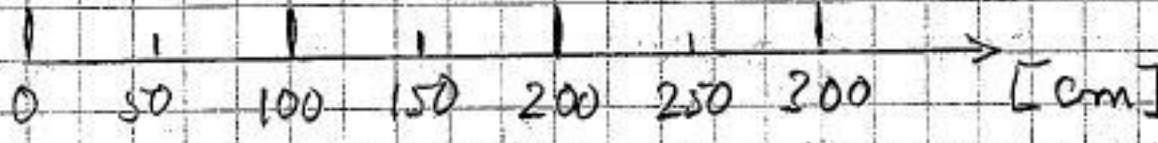
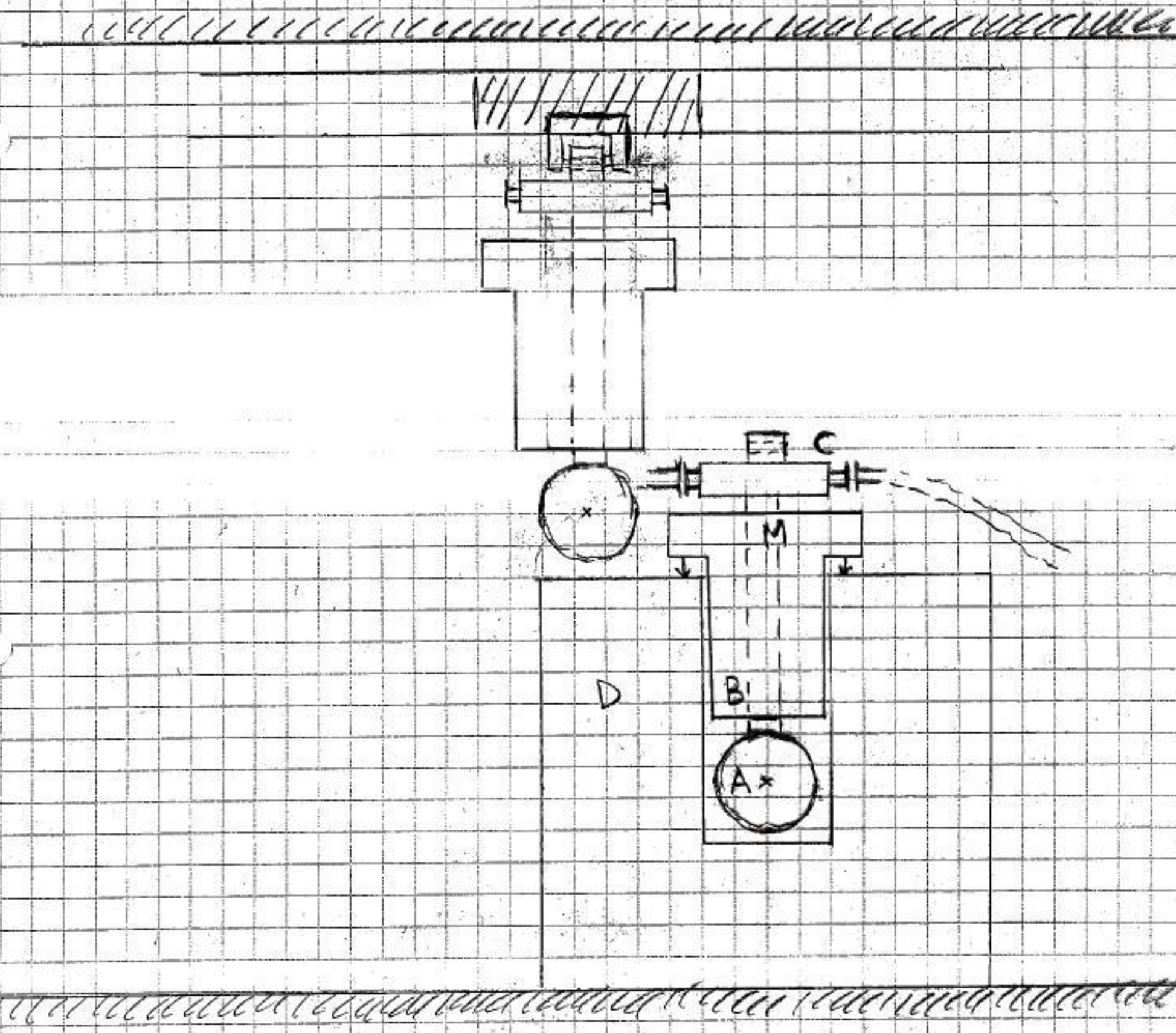

SCALE

TARGET STATION "2"

FRONT VIEW

P. SIEVERS

3/8/06

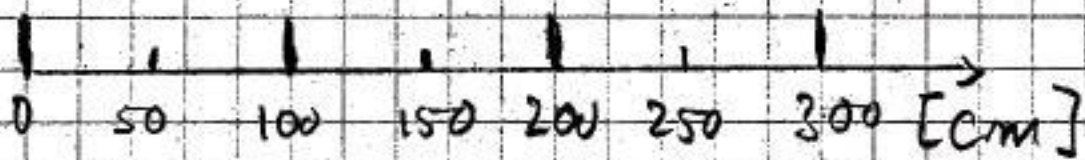
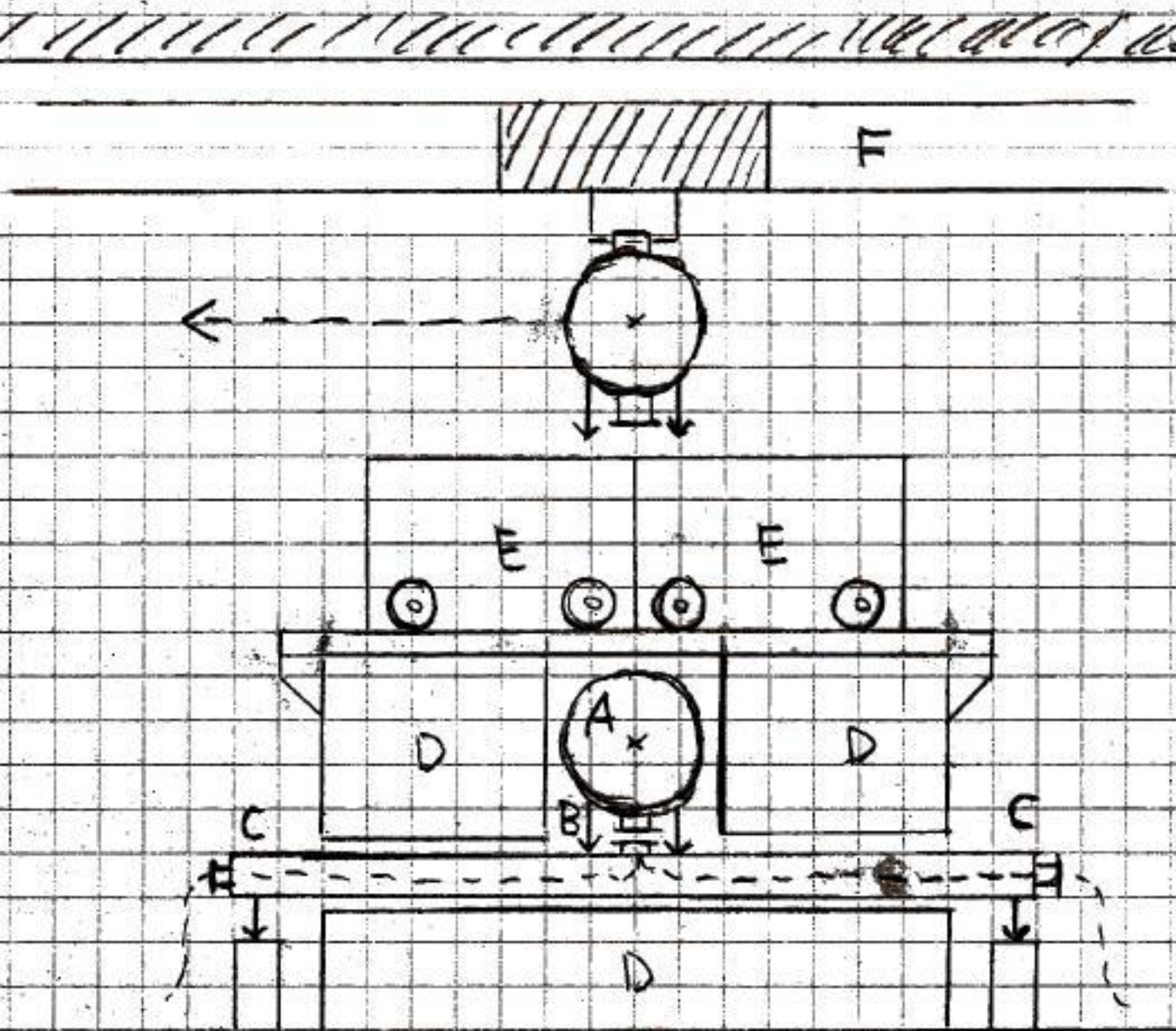

SCALE